

INORGANIC SYNTHESSES

VOLUME I

INORGANIC SYNTHESSES

VOLUME I

EDITOR-IN-CHIEF

HAROLD SIMMONS BOOTH

Western Reserve University, Cleveland, Ohio

ASSOCIATE EDITORS

L. F. AUDRIETH

University of Illinois, Urbana, Illinois

JOHN C. BAILAR, JR.

University of Illinois, Urbana, Illinois

W. CONARD FERNELIUS

The Ohio State University, Columbus, Ohio

WARREN C. JOHNSON

University of Chicago, Chicago, Illinois

RAYMOND E. KIRK

Brooklyn Polytechnic Institute, Brooklyn, N. Y.

FIRST EDITION

FIFTH IMPRESSION

McGRAW-HILL BOOK COMPANY, INC.

NEW YORK AND LONDON

1939

COPYRIGHT, 1939, BY THE
MCGRAW-HILL BOOK COMPANY, INC.

PRINTED IN THE UNITED STATES OF AMERICA

*All rights reserved. This book, or
parts thereof, may not be reproduced
in any form without permission of
the publishers.*

THE MAPLE PRESS COMPANY, YORK, PA.

To

*the countless unknown but valiant soldiers
of science upon whose labors Inorganic
Syntheses are based, this series of volumes
is dedicated in the hope that it will ease
the toil of future legions.*

PREFACE

At the Chicago meeting of the American Chemical Society, September, 1933, a group of inorganic chemists decided that there was a vital need for a series of volumes giving detailed and tested methods for the synthesis of inorganic compounds. Lack of space in chemical journals has compelled publication of material in so brief a form that frequently critical details essential to the success of a synthesis have been omitted. As a result, in an attempt to use the published synthesis, an investigator may find it necessary to rediscover the conditions that lead to success.

To meet this need, the group selected L. F. Audrieth, Harold S. Booth, W. Conard Fernelius, Warren C. Johnson, and Raymond E. Kirk, as a board of editors and asked Harold S. Booth to act as editor-in-chief to get the project under way. Later, the board of editors elected John C. Bailar, Jr., to the board.

Each synthesis in this volume has been carefully checked in the laboratory, and usually in a laboratory other than that in which the synthesis was initiated. All directions and procedures have been critically edited by each member of the board of editors with the hope of minimizing errors. The editors will deem it a favor if readers will call their attention to any errors or omissions.

Some of the methods are new, but many are improvements on older procedures. Where it was thought helpful, a critical survey of known methods introduces the synthesis and a summary of the more common properties of the substance concludes the synthesis to guide the user of the method. The references are not intended to be exhaustive.

For convenience, the book is arranged in chapters numbered according to the groups in the Mendelée

periodic table. A similar arrangement is proposed for subsequent volumes in the series. It is planned to include in Chap. IX of each volume materials and techniques of value to chemists. Future contributions of this kind are solicited by the board of editors.

Professor W. Conard Fernelius, The Ohio State University, Columbus, Ohio, has been selected by the board as editor-in-chief of Volume II of "Inorganic Syntheses." The collection and checking of syntheses for Volume II is now under way and contributions should be sent direct to Professor Fernelius. The board asks contributors to follow the style employed in Volume I, and to submit manuscripts and drawings in *triplicate*.

The editors wish to express their appreciation to those who have contributed and checked the syntheses in Volume I and ask for their continued cooperation. They likewise take this occasion to thank Dr. Roger Adams for his continuous encouragement and interest and for his kindly foreword.

The editor-in-chief wishes to thank his associates for their vigorous enthusiasm and tireless labor in the preparation of Volume I.

H. S. B.

CLEVELAND, OHIO,
March, 1939.

CONTENTS

Preface	vii
Foreword by Roger Adams.	xiii
CHAPTER I	
1. Purification of Lithium Carbonate.	1
2. Purification of Silver Residues.	2
CHAPTER II	
3. Preparation of Amalgams.	5
4. Sodium Amalgam	10
5. Barium Amalgam	11
A. By Electrolysis.	12
B. By Displacement.	14
6. Amalgams of Lanthanum, Neodymium, and Cerium.	15
7. Red Mercuric Sulfide.	19
CHAPTER III	
8. Boron Trifluoride	21
9. Potassium Fluoborate	24
10. Gallium Trichloride	26
11. Anhydrous Rare-Earth Chlorides	28
CHAPTER IV	
12. Carbon Tetrafluoride.	34
13. Trioxalato Salts.	35
A. Potassium Tri-oxalato-aluminate	36
B. Potassium Tri-oxalato-ferriate	36
C. Potassium Tri-oxalato-cobaltiate	37
D. Potassium Tri-oxalato-chromiate.	37
14. Silicobromoform (Tribromosilane)	38
15. The Higher Chlorides of Silicon	42
16. Lead Dioxide	45
17. Lead Tetracetate	47
18. Anhydrous Zirconium Bromide	49
19. Anhydrous Thorium Bromide.	51
CHAPTER V	
20. Nitrosyl Chloride	55
21. Monochloramine.	59

22. Dibromoamine	62
23. Nitrogen Trichloride.	65
24. Nitramide	68
A. Ammonium Nitrourethane.	69
B. Potassium Nitrocarbamate.	70
C. Nitramide.	72
25. Sodium Amide	74
26. Hydrogen Azide.	77
A. Aqueous Solution.	78
B. Anhydrous Ethereal Solution.	78
27. Potassium Azide (Alkali and Alkaline Earth Azides).	79
28. A. Azidodithiocarbonic Acid	81
B. Azidocarbondisulfide	82
29. Thiocyanogen Solution.	84
30. Hydroxylamine	87
31. Hydrazine Sulfate.	90
32. Recovery of Hydrazine Residues as Di-hydrochloride or Sulfate.	92
33. Guanidine Nitrate.	94
A. By Fusion of Ammonium Nitrate with Dicyandiamide	96
B. From Calcium Cyanamide and Ammonium Nitrate.	97
34. Phosphorus Pentachloride.	99
35. Crystalline Orthophosphoric Acid	101
36. Arsenic Triiodide	103
37. Antimony Triiodide	104
38. A. Hypovanadous Oxide.	106
B. Vanadium Oxytrichloride	106

CHAPTER VI

39. Oxygen Fluoride.	109
40. Hydrogen Sulfide	111
41. Thionyl Bromide	113
42. Sulfuryl Chloride	114
43. Selenium Dioxide	117
A. By Combustion of Selenium in Oxygen and Nitrogen Dioxide	117
B. By Oxidation of Selenium by Nitric Acid	119
44. Sulfur, Selenium, and Tellurium Hexafluorides	121
45. Chromous Acetate.	122
46. Chromous Chloride	125
47. Silicomolybdic Acid	127
48. Silicotungstic Acid.	129
49. Phosphotungstic Acid	132

CHAPTER VII

50. Anhydrous Hydrogen Fluoride	134
51. Fluorine	136
A. By High Temperature Method	138
B. By Medium Temperature Method	142

52. Hydrogen Chloride	147
53. Hydrogen Bromide	149
<i>A.</i> By Bromination of Tetrahydronaphthalene	151
<i>B.</i> By Catalytic Union of the Elements	152
<i>C.</i> Constant Boiling Hydrobromic Acid	155
54. Hydriodic Acid	157
<i>A.</i> By Action of Iodine on Hydrogen Sulfide	157
<i>B.</i> By Catalytic Union of the Elements	159
55. Potassium Iodide for Use as a Primary Standard	163
56. Iodine Monochloride	165
57. Iodine Trichloride	167
58. Periodates of Sodium, Potassium, and Barium	168
<i>A.</i> By the Chlorine Method	169
<i>B.</i> By the Persulfate Method	170
59. Periodic Acid	172
60. Metallic Rhenium	175
<i>A.</i> By Reduction of Potassium Perrhenate	176
<i>B.</i> By Reduction of Ammonium Perrhenate	177
61. Potassium Chlororhenite	178
62. Rhenium Pentachloride	180
63. Rhenium Trichloride	182

CHAPTER VIII

64. Tetrapyridino-Ferrous Chloride (Yellow Salt)	184
65. Gamma Ferric Oxide Monohydrate, and Gamma Ferric Oxide	185
66. Bromopentamminocobalti Bromide	186

CHAPTER IX

67. A Laboratory Cement	189
Subject Index	191
Index of Contributors	195

FOREWORD

It is with much satisfaction to all chemists that volumes are now to appear periodically describing satisfactory procedures for the synthesis of various inorganic chemicals. Although the field in inorganic chemistry may not be so extensive as that in organic chemistry, nevertheless it is equally desirable to have a reliable source of information for preparing representative compounds of the elements other than carbon. A real demand is thus to be filled.

The objective is to provide sufficient detail for each preparation so that a chemist of ordinary experience may duplicate the results on first trial. The realization of proper directions has been made possible by checking the syntheses before publication in at least one laboratory other than that of the submitter.

The first volume should assure the success of the endeavor. Many of the preparations given are of the kind for which every laboratory has a need and for which it has been almost impossible to find desirable details for synthesis.

The volumes of "Organic Syntheses" were initiated in 1921 with similar objectives and have been appearing annually since that time. Their general acceptance has indicated their usefulness and has fully justified the laborious undertaking. "Inorganic Syntheses" will no doubt be rewarded with the same success. The past and present editors of "Organic Syntheses" join with other chemists in welcoming this new enterprise.

ROGER ADAMS,
Head of the Chemistry Department

UNIVERSITY OF ILLINOIS,
March, 1939.

INORGANIC SYNTHESSES

CHAPTER I

1. PURIFICATION OF LITHIUM CARBONATE

SUBMITTED BY E. R. CALEY* AND P. J. ELVING*
CHECKED BY WILLIAM D. STILLWELL†

Since lithium salts obtainable by purchase, even of so-called "c.p." or "reagent" quality, frequently contain impurities totaling about 1 per cent, it is desirable to have a rapid method for obtaining such salts in a reasonably pure state. The following simple procedure for the purification of c.p. or reagent grade lithium carbonate provides such a method, since the resulting pure carbonate may be readily converted by treatment with the proper pure acid into practically any lithium salt desired. The procedure is based upon the fact that lithium carbonate, in contrast to the salts that contaminate it, is much less soluble in hot than in cold water.‡ In other words, simple recrystallization is employed, but the process is carried out in the reverse direction.

Procedure

Twenty-five grams of lithium carbonate is dissolved in 2 l. of water in a 3-l. beaker at room temperature. This operation requires about half an hour if stirred by a motor stirrer. Suspended impurities and any small residue of undissolved carbonate are then removed by filtering the solution, preferably through a large folded filter. The

* Princeton University, Princeton, N. J.

† Harshaw Chemical Company, Cleveland, Ohio.

‡ At 20°C., 1.33 g. of lithium carbonate is soluble in 100 g. of water; and at 100°C., the solubility drops to 0.72 g.

filtrate, in an *unscratched* beaker, is heated gradually almost to the boiling point, vigorous stirring being employed continuously to prevent adhesion of the precipitated lithium carbonate to the walls of the vessel. When precipitation is complete, the hot mixture is filtered at once, preferably through a sintered-glass filtering crucible or funnel, and the carbonate is washed two or three times with small volumes of boiling water. The salt is dried at 110°C.

The yield, based on the amount of lithium carbonate taken, is about 40 per cent. The filtrate from the second filtration may, after cooling, be again saturated with lithium carbonate to give a second crop almost as pure as the first. In this way, the total yield can be considerably increased.

For special purposes, where a product of higher purity is required, a double recrystallization from hot water may be employed; but in this case, of course, the yield is considerably reduced.

From a crude lithium carbonate containing 0.78 per cent SO₄ and 0.54 per cent foreign alkali (calculated as Na) three lots of purified lithium carbonate containing 0.03, 0.08, and 0.07 per cent foreign alkali and only traces of sulfate were obtained. The third lot was obtained by crystallizing lithium carbonate from the filtrate from a previous treatment.

2. PURIFICATION OF SILVER RESIDUES

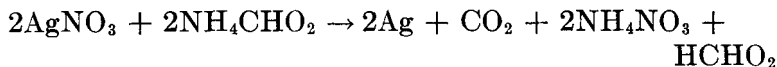

SUBMITTED BY R. N. MAXSON*

CHECKED BY H. S. BOOTH† AND C. V. HERRMANN†

Procedure

The dried silver residue is treated with aqua regia (**Care! Hood!**). After action has ceased the solution is filtered through glass wool and the residue is washed to

* University of Kentucky, Lexington, Ky.

† Western Reserve University, Cleveland, Ohio.

remove any soluble materials.* This treatment should remove lead, mercury, and the other common metals. The precipitate of silver chloride is then dissolved in the least possible amount of concentrated ammonium hydroxide (sp. gr. 0.90). This solution is filtered to remove insoluble impurities, cautiously treated with dilute nitric acid (6N) until definitely acid, and heated to coagulate the precipitated silver chloride. The precipitate is washed by decantation until the washings are neutral to litmus.

The silver chloride is transferred to a casserole, covered completely with concentrated hydrochloric acid, and stick zinc of high purity is added to reduce the silver to the elemental form. The metal is washed thoroughly with water until the last washings give no test for the chloride ion.

The metal is dissolved in dilute nitric acid (1 volume concentrated acid to 1 volume water). A large volume of distilled water is added, and the solution is permitted to stand for at least 12 hours. Tin, antimony, and bismuth, if present, are precipitated here.

The solution is filtered, and the silver precipitated again by the addition of a small excess of concentrated hydrochloric acid. After heating carefully on a water bath, the supernatant liquid is decanted. Dilute hydrochloric acid (6N) is added to the residue, and the mixture stirred thoroughly. The precipitate is allowed to settle, and the supernatant liquid is again decanted. This treatment is repeated several times, and the silver chloride is finally filtered off and washed with water until the last washings give no test for the chloride ion.† The residue is again treated with concentrated hydrochloric acid and zinc. The metallic silver is washed free from chlorides and weighed while moist.

* If the residue is not badly contaminated, the dry material should be treated with ammonium hydroxide and filtered. The filtrate is acidified with nitric acid, and the precipitated silver chloride treated as specified in the procedure.

† The washings should also give a negative test for the cupric ion.

The silver is dissolved in dilute (7.5 N) nitric acid. An excess of 20 per cent above the calculated weight of formic acid (85 per cent) needed for reduction* to metallic silver is neutralized with a slight excess of ammonium hydroxide, and the resultant solution added drop by drop to the hot silver nitrate solution. The granular precipitate of silver is washed with hot water and dried by suction or between filter papers.

* A definite excess of nitric acid must be present during this reduction.

CHAPTER II

3. PREPARATION OF AMALGAMS

BY L. F. AUDRIETH*

Introduction

An amalgam may be defined as a liquid or solid alloy one of whose components is mercury. Amalgams may consist of either liquid or solid solutions of metals in mercury, or they may be definite intermetallic compounds, such as LiHg , NaHg_2 , CsHg_4 .¹ The ability of various metals to form amalgams varies considerably. Elements that are chemically similar to mercury and in close proximity to it in the periodic table amalgamate readily. Elements with high melting points form amalgams with difficulty. Furthermore, if a metal is not wet by mercury there will be little opportunity for combination to take place unless it is effected under conditions where the mercury comes in contact with the metal in an active condition.

The solubilities of various metals in mercury at 18° C. are noted in the accompanying table. Concentration of the saturated amalgam usually results in the precipitation of the dissolved solute as a mercuride, rarely in the form of the free metal. It should be noted that metals chemically and physically similar to mercury are characterized by high solubility. The farther removed in the Mendeléev periodic table the metals are from mercury the less soluble they become. Actually none of the metals except thallium is extremely soluble; consequently, methods leading to the preparation of amalgams often give products

* University of Illinois, Urbana, Ill.

that are heterogeneous in nature. In the case of a pasty or semisolid amalgam, the crystalline material may readily be separated from the saturated solution of the metal in liquid mercury by filtration through a chamois skin. In many instances, it is possible to concentrate amalgams with respect to their metal content by heating under reduced pressure. In fact, it has been found possible to eliminate the mercury completely from an amalgam by high-temperature vacuum distillation. This method has been utilized with success in the preparation of barium, neodymium, lanthanum, and cerium.²

SOLUBILITY OF METALS IN MERCURY AT 18°³
(In percentage by weight)

Li	0.09	Mg	0.24	Sn	0.62
Na	0.68	Ca	0.30	Bi	1.4
K	0.80	Ba	0.33	Cr	3.1×10^{-11}
Rb	1.54	Zn	2.15	Mn	2.5×10^{-4}
Cs	4.34	Cd	4.92	Fe	1.0×10^{-17}
Cu	3.2×10^{-3}	Tl	42.8	Ni	5.9×10^{-4}
Ag	4.2×10^{-2}	Pb	1.3	Co	1.7×10^{-1}
Au	1.3×10^{-1}				

Various methods have been employed for the preparation of amalgams.⁴ Each has certain advantages, and each is especially applicable in certain cases. They may be grouped into four general classes:

1. Direct combination.
2. Electrolysis of a solution containing the metallic ion using a mercury cathode either in
 - a. Aqueous solutions, or in
 - b. Non-aqueous solutions.
3. Displacement of an ion from either aqueous or non-aqueous solution by a more active amalgam.
4. Displacement reactions involving the action of
 - a. An active metal upon a solution of a mercuric salt.
 - b. Mercury upon a solution of a salt of a more noble metal.

The first three are illustrated by specific examples in the syntheses that follow. Sodium amalgam (synthesis 4) is readily prepared by direct combination of the metal with mercury (illustrating method 1). Barium amalgam (synthesis 5) can be produced readily by the electrolysis of a saturated aqueous solution of barium chloride with a mercury cathode (illustrating method 2*a*). Barium amalgam is also easily obtainable by the action of sodium amalgam upon a concentrated aqueous solution of barium chloride (illustrating method 3).

Methods of direct combination are especially desirable in those cases where the metal to be amalgamated is readily available. It is generally necessary to heat the two constituents together to effect solution and reaction. Where either the metal or the product is reactive, the preparation is carried out under an inert solvent, in an atmosphere of hydrogen or nitrogen, or by heating in a vacuum in a sealed glass tube or metal bomb.

Many metals can be discharged at a mercury cathode, because of its high hydrogen overvoltage. Electrolytic methods for the preparation of amalgams have therefore been widely used and are especially advantageous, since intimate contact of mercury with the discharged metal is thereby effected. It may be assumed that the amalgamation process is a rapid one under these circumstances, because of the fact that the metal is in the active atomic state at the moment of its discharge from the ionic form. In using the electrolytic method, it is generally desirable to employ rather concentrated solutions in order that the reverse reaction of decomposition of the amalgam by the solvent may be reduced to a minimum. Furthermore, salts containing anions that are easily reduced, such as the nitrate, should not be used.

The electrolytic method is especially useful in those cases where the metals are not readily obtainable in the free state or where they are too active to permit use of the method of direct combination. Potassium, rubidium,

and cesium amalgams are obtained from solutions of the corresponding hydroxides; barium and strontium amalgams, from solutions of the chlorides.

The electrolytic method has also been applied in several cases where direct combination is not very successful because of the high melting points of the metals. Chromium amalgam has been obtained by the electrolysis of a concentrated aqueous solution of chromic chloride strongly acidified with hydrochloric acid; molybdenum amalgam, from acid solutions of the trioxide. This method has also been employed for the preparation of amalgams of such common metals as zinc, lead, cadmium, tin, bismuth, and manganese. Amalgams of aluminum, calcium, magnesium, and beryllium have not yet been obtained by the electrolysis of aqueous salt solutions.

A modification of the electrolytic method involves the electrolysis of solutions containing both the metallic and the mercuric ions. This procedure should possibly lead to the deposition of amalgams of varying composition, but no extensive study of this sort has ever been reported. Bismuth and copper amalgams have been prepared in this manner.

In some instances, non-aqueous solvents can be used to advantage, and many examples of electrodeposition from solutions of salts in solvents other than water have been reported.⁵ Electrolysis of aqueous solutions of rare earth metal chlorides at a mercury cathode results in the formation of amalgams, but at the same time a considerable quantity of basic salt precipitates which is difficult to separate. While alcoholic solutions of the chlorides are marked by a much higher resistivity to the electric current, the amalgams can be obtained from them without difficulty. Amalgams of tetramethylammonium⁶ and its higher analogs are also obtainable by electrolysis of the corresponding chlorides in alcoholic solutions at -34° . Electrolysis of ammonium thiocyanate in acetone using a mercury cathode is said to yield ammonium amalgam.⁷ It is

claimed that a very concentrated barium amalgam containing up to 30 per cent barium may be prepared by the electrolysis of barium iodide in pyridine.⁸

Where absolute purity is not required amalgams can be prepared by the action of an active amalgam, such as sodium amalgam, upon an aqueous or non-aqueous solution of a metallic salt. It is usually somewhat difficult to achieve complete reaction and the final product will always contain traces of the reacting amalgam (see the table). The method is a very simple one, especially since sodium amalgam is easily prepared. Ammonium, barium, strontium, and chromium amalgams have been prepared in this manner. Recently the rare earth metal amalgams have been prepared by the action of sodium amalgam on alcoholic solutions of the chlorides.⁹ This reaction does not take place in aqueous solution. Apparently the reaction is aided in alcohol because of the fact that sodium chloride is insoluble and precipitated from solution, thereby driving the reaction to completion as follows:

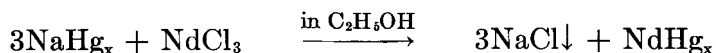

The fourth method finds limited application, although amalgamated metallic surfaces are readily prepared by dipping the metal into a solution of a mercuric salt. An illustration of the action of mercury on the solution of a salt of a more noble metal is to be found in the preparation of the silver mercuride, Ag_3Hg_4 .¹⁰ The addition of drops of mercury to a solution of silver nitrate yields crystals of this intermetallic compound.

References

1. BILTZ: *Z. anorg. allgem. Chem.*, **219**, 119 (1934).
2. AUDRIETH: *Metallwirtschaft*, **14**, 3 (1935).
3. TAMMANN and HINNÜBER: *Z. anorg. allgem. Chem.*, **160**, 249 (1927).
4. For general discussions on the subject of amalgams see (a) FRIEND: "A Textbook of Inorganic Chemistry," Vol. III, Part II, p. 215, Charles Griffin & Company, Ltd., London, 1926; (b) MELLOR: "A

Comprehensive Treatise on Inorganic and Theoretical Chemistry,"
Vol. IV, pp. 1005-1048, Longmans, Green & Company, London, 1923.

5. AUDRIETH and NELSON: *Chem. Rev.*, **8**, 335 (1931).
6. MCCOY and MOORE: *J. Am. Chem. Soc.*, **33**, 273 (1911).
7. LASZYNSKI and GORSKI: *Z. Elektrochem.*, **4**, 292 (1897).
8. HEVESY: *Z. Elektrochem.*, **16**, 672 (1910).
9. WEST and HOPKINS: *J. Am. Chem. Soc.*, **57**, 2185 (1935).
10. WERYHA: *Z. Krist.*, **86**, 335 (1935).

4. SODIUM AMALGAM

SUBMITTED BY S. H. BABCOCK, JR.*

CHECKED BY H. P. LANKELMA† AND E. VOPICKA‡

Sodium amalgams may be made by adding small pieces of sodium to mercury, by electrolysis of sodium salts using a mercury cathode, or by adding mercury to molten sodium beneath an inert liquid such as paraffin oil. The following procedure, suggested by Vanstone,¹ has advantages in both speed and simplicity.

Procedure

In an 18-cm. enameled dish are placed 60 g. of freshly cut sodium metal and enough paraffin oil to make a layer 1 cm. thick above it. The dish is placed on a hot plate, and the sodium is melted. To it, with constant stirring by hand, 1940 g. of mercury is added through a dropping funnel in such a way that the addition, though slow at first,‡ is complete in three or four minutes. Most of the paraffin oil is then decanted. As the amalgam cools, it is stirred with a heavy pestle until it begins to solidify (about 250°C.). By rapid working at this point it may be obtained in particles as small as desired. When cool

* Branch of the College of Agriculture, University of California, Davis, Calif.

† Western Reserve University, Cleveland, Ohio.

‡ If the mercury is not added rapidly, a 6 per cent amalgam melting at 360°C. will be formed. This product amalgamates only slowly with the remaining mercury. By the rapid addition, sufficient heat is generated to keep the mass molten. On the other hand, the first 10 ml. of mercury must be added dropwise, or a violent reaction will occur. As the audible sputtering of the sodium diminishes, the rate of addition may be increased.

it is washed with petroleum ether or benzene, dried, and bottled in an airtight container.

The amounts of sodium and mercury are chosen so as to yield 2 kg. of a 3 per cent amalgam. They may be changed to yield other amounts of amalgam (not exceeding 4 kg.), or amalgams of a different percentage composition.

Reference

1. VANSTONE: *Chem. News*, **103**, 181 (1911).

5. BARIUM AMALGAM

(Strontium Amalgam)

SUBMITTED BY B. C. MARKLEIN,* D. H. WEST,* AND L. F. AUDRIETH*

CHECKED BY P. A. VAN DER MEULEN†

Two methods are commonly employed for the preparation of barium amalgam: (1) the action of sodium (or potassium) amalgam on a solution of a barium salt; (2) the electrolysis of a barium salt solution using a mercury cathode. The former method was first used by Böttger¹ in describing the preparation of barium and strontium amalgams. Böttger claimed that an amalgam containing 1 part of sodium to 100 parts of mercury is readily converted into barium amalgam with only slight evolution of gas, when sodium amalgam is added to a saturated solution of barium chloride. The second method, involving the electrolytic discharge of barium in a mercury cathode, has been the subject of considerable study and investigation.²⁻⁸ It is by far the simpler method, gives a purer product, and is to be preferred to the displacement method. The directions given under procedure A are based essentially upon the results obtained by G. McPhail Smith and A. C. Bennett⁹ and involve the electrolysis of a saturated solution of barium chloride using a mercury cathode. The displacement method is given as an optional procedure.

* University of Illinois, Urbana, Ill.

† Rutgers University, New Brunswick, N. J.

Procedure

A. ELECTROLYTIC METHOD

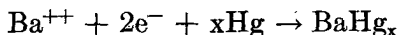

One hundred milliliters of a saturated solution of barium chloride is placed in a 250-ml. beaker, and 250 g. of pure mercury is added. Electrical contact with the latter, serving as the cathode, is made by means of a platinum wire fused through the end of a glass tube. A platinum foil (5 to 10 sq. cm.) bent at right angles, but parallel to the mercury cathode, is used as the anode.

The solution is electrolyzed for a period of 120 to 140 minutes at 1.75 to 2.5 amp. The internal and external resistances are adjusted to give a voltage drop of 6 to 7 volts across the cell. If electrolysis is continued for too long a period of time, a sudden rise in voltage occurs. This is also accompanied by marked gas evolution at the cathode surface and decomposition of the amalgam due to interaction with the spent electrolyte. This phenomenon may also be due to the formation of crystals of barium amalgam which form a crust on the cathode surface. This difficulty can be avoided either by mild agitation of the mercury surface using an automatic stirrer or by occasionally pushing the crystal mass below the mercury surface with a flattened stirring rod.

At the conclusion of the electrolysis the electrolyte is decanted, and the amalgam is washed several times with distilled water, with alcohol, and finally with ether. The amalgam is preserved in a bottle with a tightly fitting glass stopper.

Results of three typical runs are given in Table I. The product is heterogeneous in character and consists of crystals of solid amalgam mixed with the dilute liquid amalgam. For analysis, samples were removed immediately after electrolysis and allowed to decompose for a period of five to six days in contact with air. The mass

TABLE I

	Time, sec.	Amperage, av.	Voltage, av.	Current density, amp./sq. cm.	Wt. of Hg used, g.	Wt. of Ba, g.		Current efficiency, %	% Ba in amalgam
						Theoretical	Actual		
Experiment I*	14,400	1.98	6.56	0.070	504				
Analysis:									
1.....						20.29	17.1	84.5	3.29
2.....						20.29	14.2	70.0	2.74
Average.....						77.25	3.01
Experiment II	8,100	2.194	6.83	0.077	278.35				
Analysis:									
1.....						12.63	8.55	67.67	2.97
2.....						12.63	8.26	65.40	2.88
Average.....						66.53	2.92
Experiment III	7,200	1.753	5.35	0.062	285.3				
Analysis:									
1.....						8.98	6.61	73.6	2.73
2.....						8.98	6.18	68.8	2.56
Average.....						71.2	2.64

* In the analysis of the first sample, an attempt was made to obtain an almost entirely crystalline amalgam. This accounts for the high barium content in sample I, analysis 1.

was stirred occasionally to insure complete decomposition. The resulting mixture of barium hydroxide and barium carbonate was dissolved in dilute hydrochloric acid, and the barium in the solution determined as barium sulfate. The mercury was dried and weighed.

B. DISPLACEMENT METHOD

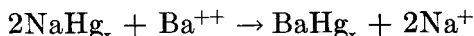

The procedure described here consists in adding powdered sodium amalgam to a saturated aqueous solution of barium chloride and stirring until the reaction is practically complete.

The sodium amalgam powder containing 2 to 2.5 per cent sodium by weight (synthesis 4) is added to an excess of a saturated solution of barium chloride. By means of a flattened stirring rod the reaction product is gradually worked from a powdery into a pasty, semisolid mass. If it is desirable to reduce to an absolute minimum the amount of sodium remaining in the amalgam, the product may be stirred further with fresh barium chloride solution.

Results of a typical preparation are presented in Table II. In this experiment, a sodium amalgam containing 1.97 per cent sodium was added to a saturated solution of barium chloride. Samples were taken at various intervals and analyzed for their barium and sodium content.

TABLE II

Min.	Wt. of Hg, g.	Wt. of BaSO ₄ , g.	Ba content, g.	Wt. of Na ₂ SO ₄ , g.	Na content, g.	% Ba	% Na
5	8.46	0.5930	0.3485	0.0345	0.0112	3.95	0.127
10	11.81	0.7084	0.4170	0.0280	0.0091	3.41	0.074
15	10.71	0.6319	0.3720	0.0071	0.0023	3.36	0.020
20	10.03	0.5938	0.3500	0.0054	0.0017	3.36	0.017
25	10.25	0.5939	0.3500	0.0046	0.0015	3.30	0.014

References

1. BÖTTGER: *J. prakt. Chem.*, **1**, 302 (1834).
2. DAVY: *Phil. Trans.*, **98**, 343 (1808).

3. BUNSEN: *Pogg. Ann.*, **91**, 619 (1854).
4. MAQUENNE: *Bull. soc. chim.*, [3] **7**, 366 (1892); *Ann. chim. phys.*, [6] **29**, 216 (1893).
5. KERP, BÖTTGER, and IGGENA: *Z. anorg. allgem. Chem.*, **25**, 45 (1900).
6. IGGENA: thesis, Göttingen, 1899.
7. LANGBEIN: thesis, Königsberg, 1900.
8. SMITH and WITHROW: *J. Am. Chem. Soc.*, **29**, 324 (1907).
9. SMITH and BENNETT: *J. Am. Chem. Soc.*, **31**, 804 (1909).

6. AMALGAMS OF LANTHANUM, NEODYMIUM AND CERIUM

SUBMITTED BY E. E. JUUKOLA,* L. F. AUDRIETH,* AND B. S. HOPKINS*
CHECKED BY P. A. VAN DER MEULEN†

Although rare earth metal amalgams may be prepared by the direct combination of metals with mercury, this procedure cannot be employed generally, because the metals themselves are not commonly available except in a rather impure state or in the form of alloys such as misch metal. In order to prepare pure rare earth metal amalgams, recourse must be had to an electrolytic method involving the use of pure salts. Although it is possible to prepare rare earth amalgams by electrolysis of aqueous solutions,¹ using a mercury cathode, this procedure is not recommended: first, because the highly reactive amalgams are rapidly decomposed by water with resultant formation of the corresponding hydroxides and, second, because the yields are small. They can, however, be prepared readily by electrolyzing alcoholic solutions of the anhydrous chlorides using a mercury cathode.²

This method may be used for the preparation of the amalgams in any desired quantity.

Procedure

Apparatus. The electrolytic cell consists of a 250-ml. widemouthed Erlenmeyer or Florence flask (pyrex) into

* University of Illinois, Urbana, Ill.

† Rutgers University, New Brunswick, N. J.

the bottom of which is sealed a platinum wire to make contact with the mercury cathode. Through a three-hole rubber stopper, which fits the mouth of the vessel, are introduced a stirrer, a graphite rod, and an outlet vent. The stirrer is adjusted so that it agitates slightly the surface of the mercury cathode.* The graphite rod is fitted with a graphite disc which serves as the anode† and is placed parallel to and about 2 cm. distant from the cathode surface. The apparatus is depicted in Fig. 1.

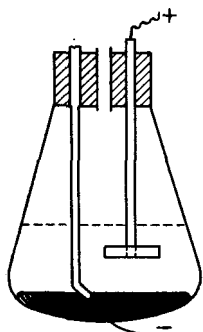

FIG. 1.—Cell for preparation of rare earth amalgams.

Manipulation. A concentrated solution of the anhydrous rare earth chloride‡ in ethyl alcohol (20 to 30 g. chloroform per 100 ml. absolute ethanol) is electrolyzed using a 110-volt direct current with the cell in series with a variable resistance. The current density should not exceed 0.05 to 0.1 amp. per square centimeter in order to prevent dispersion of the mercury. The solution is electrolyzed for 15 to 40 hours.

Under these conditions, a liquid to pasty amalgam is obtained containing 1 to 3 per cent of rare earth metal by weight. Results of typical runs are given in the accompanying table.

Upon conclusion of the electrolysis, the electrolyte is decanted as completely as possible from the amalgam. The

* Agitation of the mercury surface is necessary (1) to prevent formation of a crust of solid amalgam, (2) to keep the cathode clear of any basic salts or sediment which might form, and (3) to minimize any marked tendency towards formation of solvo-basic products, by preventing impoverishment of ions at the cathode.

† A platinum flag anode may also be used. It has been found, however, that appreciable anodic corrosion takes place with the result that the amalgam is contaminated with platinum.

‡ The rare earth chlorides are best prepared by the method outlined in synthesis 11. The presence of insoluble material, due to partial hydrolysis or incomplete reaction, need offer no difficulties. The insoluble constituents are allowed to settle out and the clear saturated solution decanted into the electrolytic cell.

latter is placed in a beaker and washed free from sediment by directing a vigorous stream of water on to the amalgam. Immediate washing with successive portions of alcohol and with ether yields a product free from all foreign ingredients and sediment. The amalgam is transferred rapidly into a pyrex tube which is evacuated and sealed off. The amalgam may also be kept in an atmosphere of some inert gas such as carbon dioxide or under a saturated solution of the electrolyte. If exposed to air, rapid decomposition with formation of the hydrous oxide takes place.

PREPARATION OF RARE EARTH METAL AMALGAMS

Amount and salt used	Vol. of C_2H_5OH , ml.	Conc. of amalgam, % by weight	Time of electrolysis, hr.	Average current density, amp./sq. cm.
10.7 g. $NdCl_3 \cdot H_2O$	40	1.12	25	0.05
10.6 g. $NdCl_3$	40	3.33	15	0.22
10.6 g. $NdCl_3$	40	2.66	40	0.05
11.28 g. $LaCl_3$	120	2.1	39	0.02
13.15 g. $CeCl_3 \cdot H_2O$	50	0.87	27	0.07
15. g. $CeCl_3$	90	good	20	0.02

Concentration of Amalgams. Rare earth metal amalgams may be concentrated with respect to their rare metal content by removal of mercury through distillation under reduced pressure. An all-glass distilling apparatus should be used for this purpose, since cork or rubber stoppers will not withstand the temperature required to eliminate much of the mercury. The apparatus depicted in Fig. 2 has been found satisfactory for this purpose.

A pyrex tube *A*, 25 mm. in diameter, closed at one end, is sealed at the point *B* to a piece of tubing which is connected with a receiver consisting of a 250-ml. distilling flask. The upper end is constricted at the point *C*. A stream of dry carbon dioxide is passed through the apparatus from *D* to displace the air. After the dilute amalgam

has been introduced at *E*, the distilling vessel is sealed off at the point *C*. The vacuum line leading to a Hyvac pump is attached at the point *D*, and the system is exhausted. The distilling vessel is placed in a Woods metal bath, and the temperature raised gradually to about 235°C. Rapid heating should be avoided to prevent bumping and consequent loss of rare earth metal.

As the mercury is removed, the liquid or pasty amalgam changes gradually to a grayish-black, powdery mass containing approximately 15 per cent of rare earth metal by

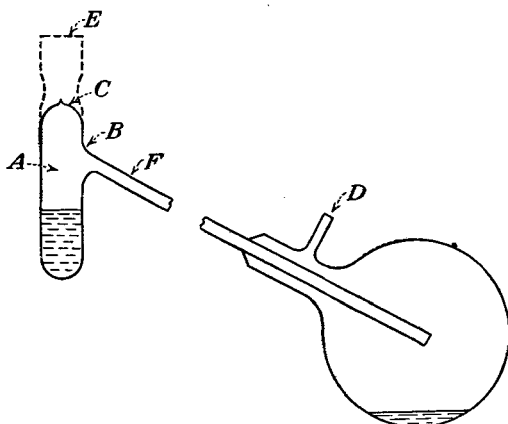

FIG. 2.—Apparatus for concentrating rare earth amalgams.

weight. When no more mercury distills over, the heating is discontinued, and the vessel removed from the heating bath and allowed to cool. The vacuum pump is kept operating until the apparatus has come to room temperature. Dry carbon dioxide is introduced into the system through a two-way stopcock, and the vessel containing the concentrated amalgam is sealed off at the point *F*.

These concentrated amalgams are very pyrophoric and on contact with air or moisture take fire or glow. By heating to temperatures around 1000°C. in a vacuum furnace the remainder of the mercury may be removed to give the rare earth metals in very pure form.^{2b, 2c}

References

1. HOPKINS and AUDRIETH: *Trans. Am. Electrochem. Soc.*, **66**, 135 (1934).
2. (a) AUDRIETH, JUKKOLA, MEINTS, and HOPKINS: *J. Am. Chem. Soc.*, **53**, 1805 (1931); (b) JUKKOLA, AUDRIETH, and HOPKINS: *J. Am. Chem. Soc.*, **56**, 303 (1934); (c) MEINTS, HOPKINS and AUDRIETH: *Z. anorg. allgem. Chem.*, **211**, 237 (1933).

7. RED MERCURIC SULFIDE

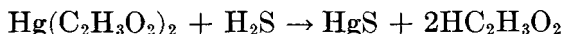

SUBMITTED BY LYMAN C. NEWELL,* R. N. MAXSON,† AND M. H. FILSON‡

CHECKED BY W. C. FERNELIUS‡

When hydrogen sulfide reacts with mercuric chloride in neutral or acid solution, or when mercury and sulfur are ground together, black mercuric sulfide is formed. Under certain conditions, this material can be converted into the red modification by the continued action of soluble alkali sulfides. The reaction of mercuric chloride and sodium thiosulfate gives the red form if the ratio of the concentrations is higher than 1:4.¹ The red sulfide is also produced when the substance $\text{Hg}(\text{SH})\text{NCS}$ is boiled with concentrated ammonium thiocyanate solution or when hydrogen sulfide is conducted into a warm mercuric salt solution in the presence of acetic acid and an excess of ammonium thiocyanate, or thiourea.^{2,3}

Procedure

Thirty-five grams of mercuric acetate and 25 g. of ammonium thiocyanate are dissolved in 100 ml. of hot glacial acetic acid. A steady stream of hydrogen sulfide is conducted into the hot solution until precipitation is complete. Then the acetic acid is slowly evaporated. (**Caution!** Hydrogen cyanide gas is evolved.) The black precipitate that first appears slowly changes to the red modification as the acid boils away. Until this change is

* Boston University, Boston, Mass. Deceased.

† University of Kentucky, Lexington, Ky.

‡ The Ohio State University, Columbus, Ohio.

complete, glacial acetic acid must be present, and the boiling continued. Overheating must be avoided. At the last stages, the paste should be stirred constantly. If this precaution is neglected, a dull-red or brown-colored product is obtained.

When the acid is completely removed, cool, add 200 ml. of distilled water, and filter on a Büchner funnel. Wash and dry the product between sheets of absorbent paper. Yield 25 g. (98 per cent).

If mercuric chloride is used instead of the acetate, a larger amount of acetic acid is required, and a longer period of heating is needed. The color changes from black, through brown, tan, and orange to red, but the final color is never so brilliant a vermilion as that of the material prepared from the acetate.

Properties

Cinnabar, or vermilion (sp. gr. 7.5 to 8.1), is the stable modification of mercuric sulfide at all temperatures up to its sublimation point (about 580°C.). Its chemical properties are about the same as those of the black modification, and its stability makes it useful as a pigment for artists' colors.

References

1. ALLEN, CRENSHAW, and MERWIN: *Am. Jour. Sci.*, [4] **34**, 351 (1912).
2. VENKATARAMAIAH and RAO: *J. Sci. Assoc., Maharajah's College*, **1**, 4i (1923); *Chem. Abstr.*, **18**, 626 (1924); *Nature*, **111**, 775 (1923); *Chem. Abstr.*, **17**, 2667 (1923).
3. WEISER: "The Colloidal Salts," pp. 94-96, 118-119, McGraw-Hill Book Company, Inc., New York, 1928.

CHAPTER III

8. BORON TRIFLUORIDE

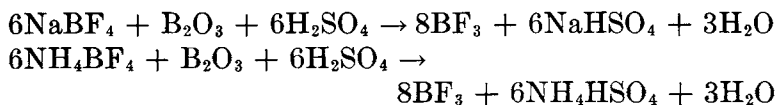

SUBMITTED BY H. S. BOOTH* AND K. S. WILLSON*

CHECKED BY S. H. BABCOCK, JR.†

The usual method of preparing boron trifluoride from calcium fluoride, boric oxide, and sulfuric acid is unsatisfactory, since yields are low, much silicon fluoride contaminates the product, and a solid residue which is difficult to remove remains in the generator.

Using sodium fluoborate or ammonium fluoborate,¹ boric oxide, and sulfuric acid, the yields are good, little silicon fluoride is produced, and the residue is water soluble.

Procedure

PART A. PREPARATION OF HIGH-PURITY BORON TRIFLUORIDE

Three hundred grams of sodium fluoborate‡ and 50 g. of anhydrous boric oxide are ground together, and the mixture is placed in a liter flask equipped with a standard conical joint. About 300 ml. of concentrated sulfuric acid is added, and the flask is swirled to mix the solid and liquid thoroughly. The flask *A* (Fig. 3) is then connected to the system, using on the conical joint *B* a grease made by saturating a hot 1:4 mixture of paraffin and vaseline with

* Western Reserve University, Cleveland, Ohio.

† Branch of the College of Agriculture, University of California, Davis, Calif.

‡ Since ammonium fluoborate is more readily purified by recrystallization, 287 g. of it may be used in place of the sodium fluoborate.

boron trifluoride and pumping off the excess boron trifluoride at $+130^{\circ}\text{C}$.

Stopcock *D* is opened, and the system is evacuated; then stopcock *D* is closed so that the boron fluoride will be forced to bubble through the wash bottle *E* which contains concentrated sulfuric acid saturated cold with boric oxide to remove hydrofluoric acid and moisture which escapes from the flask and condenser *C*.

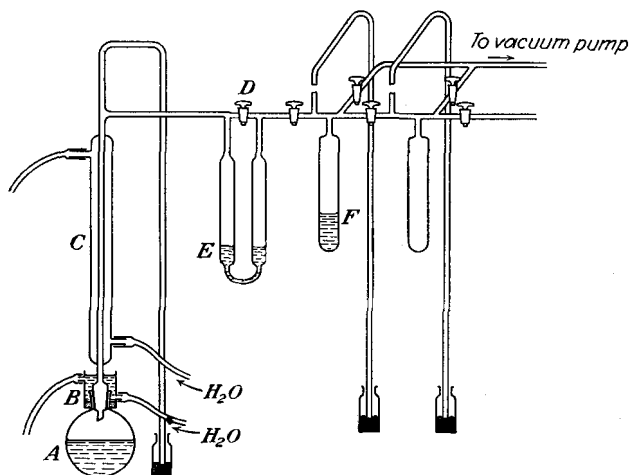

Fig. 3.—Apparatus for the preparation of high-purity boron fluoride.

The flask is gently heated. Frothing will occur at first but may be checked by flaming the flask at the liquid surface locally with a hand torch. When frothing ceases, the mixture should be heated strongly.

The boron trifluoride is condensed in the ampoules *F*, drawing the gas into one ampoule surrounded by liquid air while the other is warming to melt down the boron trifluoride into the bottom of the ampoule. The boron trifluoride may be partially purified by distilling from one ampoule to another, discarding first and last portions. If a very pure product is required, it may be easily produced by fractionating the boron trifluoride in a column of the type described by Booth and Bozarth.² One such distillation yields a spectroscopically pure boron trifluoride.

the reacting organic compounds. Excess boron trifluoride passes through the calcium chloride tube *V* to the hood.

The amount of boron trifluoride absorbed by the reacting organic compounds can be determined from time to time by turning the three-way stopcock *S* so as to by-pass the boron trifluoride through the shunt and closing the stopcocks *S'* to protect the contents of the flask *R* from the atmosphere. The part of the apparatus from *G* to *G'* can then be removed and weighed.

Properties

Boron trifluoride is a colorless gas which fumes in air and has a pungent suffocating odor. It melts at -127°C . and boils at -101°C . Its critical temperature is -12.25°C ., and the critical pressure is 49.2 atm.

References

1. BOOTH and WILLSON: *J. Am. Chem. Soc.*, **57**, 2273 (1935).
2. BOOTH and BOZARTH: *Ind. Eng. Chem.*, **29**, 470 (1937).

9. POTASSIUM FLUOBORATE

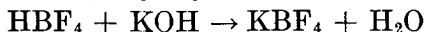
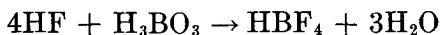

SUBMITTED BY P. A. VAN DER MEULEN* AND H. L. VAN MATER*

CHECKED BY SISTER M. JOSETTA BUTLER, R.S.M.,† AND L. F. AUDRIETH†

Salts of fluoboric acid are nearly always contaminated by fluorides. The reason for such contamination is twofold. In the first place, the reaction by means of which fluoboric acid is formed is reversible, and, in the second place, most of the common salts of fluoboric acid crystallize as hydrates which show a marked tendency to hydrolyze with their water of hydration. Drying at higher temperatures markedly increases the rate of hydrolysis.

Potassium fluoborate possesses certain distinct advantages over the other salts of fluoboric acid. Not only can

* Rutgers University, New Brunswick, N. J.

† University of Illinois, Urbana, Ill.

it be prepared very readily, but it is one of the less soluble salts and under ordinary conditions is not hydrated and can be dried without serious decomposition.

Procedure

The calculated quantity of concentrated (47 per cent) hydrofluoric acid is placed in a platinum* dish set in an ice bath. The required amount of solid boric acid is then added in very small portions at intervals of several minutes.† After all of the boric acid has been added, the solution is allowed to stand at room temperature for five or six hours to allow the reaction to proceed with the formation of a maximum quantity of fluoboric acid.

The dish containing the solution of fluoboric acid is again placed in an ice bath, and 5N potassium hydroxide solution is added slowly, with stirring, until a test portion gives an alkaline reaction with methyl orange. The solution is kept in an ice bath until it is chilled and the crystals of potassium fluoborate have settled.

The crystal mass is then separated from the mother liquor by careful decantation or by filtration through a Büchner funnel. In either case, the product is carefully washed several times with cold distilled water,‡ then with 95 per cent ethyl alcohol and with ether. If the crystals are washed by decantation, the yield may not exceed 75 per cent. If absolute purity is not essential, and filtration is carried out on the Büchner funnel, the yield may be considerably higher as indicated by the following experimental results.

In duplicate runs, 100 ml. of 47 per cent hydrofluoric acid was treated with 36.3 g. of pure boric acid as described above. The resulting solution was neutralized with 5N

* Where absolute purity is not necessary, hard rubber ware may be substituted for platinum.

† If the boric acid is added in too large amounts, or at too frequent intervals, the heat of reaction is sufficient to cause considerable vaporization of hydrogen fluoride.

‡ Careful washing with water is necessary in order to remove all fluoride.

potassium hydroxide yielding, after washing and drying, 63.5 and 69 g. of potassium fluoborate, corresponding to yields of 86 and 93 per cent.

Properties

The potassium fluoborate prepared in the foregoing manner is stable for an indefinite period in the dry state. Fresh solutions of the compound give no precipitate of lead fluochloride when added to a filtered, saturated solution of lead chloride. Such solutions are stable for several hours after preparation, but hydrolysis takes place gradually. Samples of pure potassium fluoborate prepared using every precaution indicated in the foregoing procedure were found to have the following composition:

Potassium, calc. 31.0%; found 31.02%.

Fluorine, calc. 60.4%; found 60.6%.

10. GALLIUM TRICHLORIDE

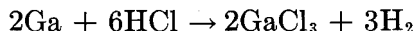

SUBMITTED BY W. C. JOHNSON* AND CALEB A. HASKEW*

CHECKED BY FREDERIC B. DUTTON†

Gallium trichloride, GaCl_3 , may be prepared by the direct combination of the elements at slightly elevated temperatures.¹ Unlike indium, which forms the dichloride by reaction with hydrogen chloride gas,² gallium forms the trichloride. This method yields pure gallium trichloride and, in addition, eliminates the use of chlorine which is often objectionable.

Procedure

Hydrogen chloride (see synthesis 52) is dried by passage through a train of wash bottles containing concentrated sulfuric acid and a 30-in. drying tower filled with calcium chloride. Pure metallic gallium is obtained by the elec-

* University of Chicago, Chicago, Ill.

† Baldwin-Wallace College, Berea, Ohio.

trolysis of an alkaline solution of a gallium salt according to the procedure described by Uhler and Browning.³

The gallium (1 to 2 g.) is weighed into a porcelain boat, and the latter inserted into a pyrex tube 50 cm. in length and 2 cm. in diameter. A portion of this tube is surrounded by a small resistance furnace the temperature of which is controlled by an outside rheostat. After the air in the apparatus has been displaced by hydrogen chloride, the temperature of the furnace is allowed to rise slowly to 200°C. This temperature is maintained until all the gallium has disappeared from the boat. Reaction proceeds slowly at a temperature as low as 75°C., but the higher temperature is desirable because of the sublimation of the chloride to the cooler parts of the pyrex tube. Accordingly, a clean surface of the metal is always exposed.

After the gallium metal has disappeared, the apparatus is allowed to cool, the hydrogen chloride generator is disconnected, and finally a stream of nitrogen gas is admitted to displace the hydrogen chloride gas. The sublimed product is sealed from the apparatus and then analyzed for chlorine and gallium by the usual gravimetric methods; the chlorine is determined as silver chloride and the gallium as gallic oxide. Calculated for gallium trichloride, Ga: 39.59 per cent, found: 39.42, 39.50 per cent; Cl: 60.41 per cent, found: 60.48, 60.45 per cent. The yield is 100 per cent based on the gallium used.

Properties

Gallium trichloride is a white crystalline solid melting at 76°C. It is readily sublimed *in vacuo* below its melting point. It is exceedingly hygroscopic and is readily hydrolyzed in an aqueous medium.

References

1. LECOQ DE BOISBAUDRAN: *Compt. rend.*, **86**, 577 (1878); **86**, 756 (1878); **93**, 294, 329 (1881).
2. THIEL: *Z. anorg. Chem.*, **40**, 303 (1904).
3. UHLER and BROWNING: *Am. J. Sci.*, [4] **42**, 389 (1916).

11. ANHYDROUS RARE EARTH CHLORIDES



SUBMITTED BY JAMES B. REED,* B. S. HOPKINS,* AND L. F. AUDRIETH*
CHECKED BY P. W. SELWOOD† AND BY R. WARD‡ AND J. J. DEJONGH‡

The preparation of the anhydrous chlorides of the rare earth elements is of considerable interest, since these compounds serve as the starting materials in the preparation of the metals, either directly by electrolysis in the fused state or indirectly by electrolysis in alcoholic solutions with a mercury cathode followed by the subsequent thermal decomposition of the resulting amalgams. The most important methods for the preparation of anhydrous rare earth chlorides previously suggested are: from the metals, by action of dry chlorine, hydrogen chloride, or methyl chloride¹ at elevated temperatures; from the oxides, by action of chlorine in the presence of a reducing agent,² by action of hydrogen chloride alone³ or with carbon,⁴ by action of carbon tetrachloride,⁵ carbonyl chloride,⁶ sulfur monochloride vapor⁷ (or a mixture of sulfur monochloride and chlorine),⁸ by heating with phosphorus pentachloride,³ by mixing with a slight excess of ammonium chloride and gradually dropping the mixture into a red-hot crucible;⁹ from the sulfides, by heating in dry hydrogen chloride;¹⁰ from the carbides, by heating with chlorine¹¹ or in a current of hydrogen chloride;¹² from the hydrated chlorides, by heating in a current of hydrogen chloride gas,¹³ by adding ammonium chloride to a solution of the chlorides, evaporating to dryness, and heating in air¹⁴ or in a current of HCl,¹⁵ by dehydration in an atmosphere of carbonyl chloride (or a mixture of carbon monoxide and chlorine¹⁶), by heating in air and treating the resulting mixture of chlorides and oxychlorides with sulfur monochloride and chlorine or sulfur monochloride, chlorine, and hydrogen chloride mixtures, by extracting the chloride-oxychloride

* University of Illinois, Urbana, Ill.

† Northwestern University, Evanston, Ill.

‡ Polytechnic Institute of Brooklyn, Brooklyn, N. Y.

mixture with anhydrous alcohol followed by filtration and evaporation of the solution and subsequent removal of organic matter by heating in a current of dry air;¹⁷ and, from the benzoates, by extraction with ether saturated with dry hydrogen chloride.¹⁸

None of the methods mentioned above is entirely satisfactory for making large quantities of the anhydrous rare earth chlorides. Some of them give products that always contain considerable basic material. Others are suitable for the preparation of only a few grams of chloride at a time. The method involving the dehydration of the hydrated salts in dry hydrogen chloride, although adapted to the preparation of a pure product in large quantities, requires careful temperature control and is time consuming. It is, however, still to be recommended in those cases where materials of highest purity are required.

The method outlined below can be employed for the preparation of any desired quantity. It can also be adapted to the preparation of other anhydrous chlorides having high melting and boiling points, such as magnesium and manganous chlorides, but is not suitable for preparing volatile chlorides, such as aluminum chloride.¹⁹ The procedure is simple and requires only 24 to 36 hours for completion. The necessary apparatus is readily obtainable and easily constructed from materials available in any laboratory.

The method²⁰ consists essentially of heating a mixture of rare earth oxides and excess ammonium chloride to a temperature of 200°C. or higher. Hydrolysis of the rare earth chlorides with formation of basic compounds is effectively prevented by the presence of excess ammonium chloride. The remaining ammonium chloride is then removed completely by heating in a vacuum at 300 to 320°C.

Procedure

Apparatus. For the removal of the excess ammonium chloride, the apparatus shown in Fig. 5 has been found

satisfactory. The mixture of rare earth chloride and ammonium chloride is placed in the 1-l., round-bottom pyrex flask *A*. This flask is placed in the furnace *B* and is connected to the delivery tube *C* by means of an interchangeable ground-glass connection *D*.* The delivery tube *C* has an internal diameter of 28 mm. At the point where it leaves the furnace, it is sealed to the bulb *E*, having a capacity of about 500 ml., which serves as a receiver for

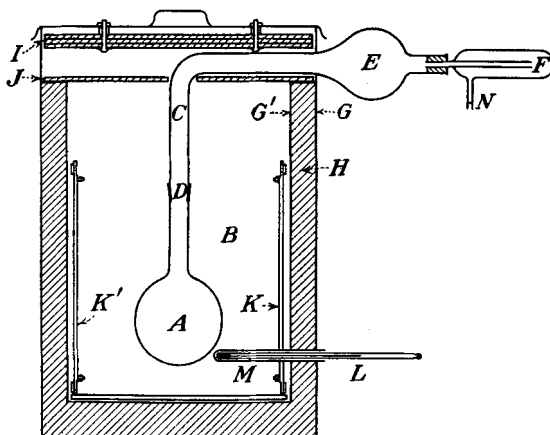

FIG. 5.—Furnace for synthesis of rare earth chlorides.

the ammonium chloride. The bulb *E* is connected by a rubber stopper to the trap *F* which retains any fine particles of rare earth chloride that may be carried over by the gaseous ammonium chloride. The trap is connected to a high-vacuum pump through the tube *N*. The pressure in the system is indicated by a closed-end manometer placed in the vacuum line.†

The furnace consists of two galvanized-iron cans *G, G'* set one inside the other. The space between them is packed with ground asbestos *H*. Several layers of asbestos board *I* are bolted to the cover. An inner cover *J* through

* Catalogue GG 5-38, size 34/45, made by the Scientific Glass Apparatus Company, Bloomfield, N. J. These connections have been found to lose only a few millimeters of vacuum per hour when used without lubricant.

† A vacuum of 0.5 to 2.0 mm. of mercury can easily be maintained.

which the delivery tube passes is made of two semicircular pieces of asbestos board.

The heating unit consists of six Westinghouse No. 299,-425 space heaters *K, K'* of 110-volt and 220-watt capacity. These heaters are placed at regular intervals around the inner wall of the furnace. Their ends are bolted to two iron rings, thus making of the heating unit a cylindrical cage which can easily be removed from the furnace for rewiring or alteration. The heaters are connected in parallel, and the temperature is controlled by a lamp bank. A thermometer *L*, protected by a pyrex tube *M*, is located near the bottom of the furnace. The glass apparatus is supported within the furnace by means of a ring stand and clamp.*

Method and Manipulation. Fifty grams (0.15 mol) of rare earth oxides is intimately mixed with 100 g. (1.8 mol) of finely divided ammonium chloride. The mixture is divided into two portions, placed in casseroles of 500 ml. capacity, each of which is heated on a wire gauze with an asbestos center about 10 cm. above a Bunsen burner using a flame 20 to 25 cm. high. During the heating, the contents of the casseroles are stirred frequently.

If a dark colored oxide is being treated, the reaction is easily followed by the change in color of the mixture. The heating should be continued until test portions are completely soluble or the test solutions show only slight opalescence. This usually requires from 1 to 3 hours.

As soon as the mixture has been found to be completely soluble, it is transferred to the flask *A* of the apparatus described above, placed in the furnace, and the vacuum applied. The temperature of the furnace is then raised

* For the preparation of small quantities of rare earth chlorides, the apparatus may be modified as follows: The mixture of rare earth chloride and ammonium chloride is placed in porcelain boats, and the boats are enclosed in a pyrex tube about 50 cm. long and 25 mm. internal diameter. One end of the tube is sealed, and the other is connected to the vacuum pump through a trap. The part of the tube containing the boats is heated in a tube furnace to the required temperature.

during the course of 2 or 3 hours to 300 to 320°C. and held at this point as long as any ammonium chloride continues to sublime over.

In order to determine whether all of the ammonium chloride has been driven over, it is necessary only to remove the outer cover of the furnace for a few minutes and observe whether any sublimate forms in the exposed portion of the delivery tube. The heating is then continued for 2 or 3 hours to insure complete removal of the ammonium chloride. The heating in vacuum requires from 12 to 30 hours. The product is allowed to cool in the vacuum, and dry air is then admitted to the apparatus.

It is usually necessary to remove the flask and delivery tube from the furnace and to heat the ground-glass connection gently in order to get it apart. The product is quickly transferred to dry containers which can be stoppered tightly.*

The product is obtained in the form of a finely divided powder. It is extremely hygroscopic and hisses on addition of water. The water solution is clear or only slightly cloudy. No ammonia can be detected. The following analyses indicate in every case that the products obtained by employing this procedure consist of fairly pure rare earth chlorides.

ANALYSES

Nature of oxide	% Cl		% rare earth	
	Found	Theory	Found	Theory
95 % La, 5 % Pr.....	42.82	43.35	56.85	56.65
95 % La, 5 % Pr.....	43.46	43.35	56.61	56.65
60 % La, 40 % Pr.....	43.29	43.22	56.28	56.78
Pure Nd.....	42.77	42.43	57.3	57.57

* The transference of the product to the containers is greatly facilitated by use of a funnel made from a piece of glass tubing which fits over the neck of the flask in which the heating is carried out and is drawn out to fit into the mouths of the containers. It is then necessary only to place the funnel over the neck of the flask, place the container over the end of the funnel, and invert all three.

Since the rare earth oxides always contain varying amounts of carbonate and hydrated oxide, it is impossible to calculate the exact percentage yields. However, the yields tabulated below on the assumption that the starting materials are the uncontaminated rare earth oxides demonstrate that the method is very efficient.*

YIELDS

Nature of oxide	Wt. of oxide taken, g.	Wt. of NH ₄ Cl used, g.	Wt. of chloride obtained, g.	% yield
60 % La, 40 % Pr.....	50.00	100	66.0	89.7
35 % La, 5 % Pr, 60 % Nd..	50.00	100	64.5	86.0
60 % La, 40 % Pr.....	50.00	100	69.70	93.7
60 % La, 40 % Pr.....	50.54	100	67.63	90.0
Pure Nd.....	75.56	150	107.52	95.5

References

1. MUTHMANN and KRAFT: *Ann.*, **325**, 261 (1902).
2. DIDIER: *Compt. rend.*, **101**, 882 (1885).
3. MATIGNON: *Ann. chim. phys.*, [8], **8**, 364 (1906).
4. PETERSSON: *Z. anorg. Chem.*, **4**, 1 (1893).
5. MEYER: *Ber.*, **20**, 681 (1887).
6. CHAUVENET: *Compt. rend.*, **152**, 87 (1911).
7. HICKS: *J. Am. Chem. Soc.*, **33**, 1492 (1911).
8. BOURION: *Ann. chim. phys.*, [8], **20**, 547 (1910).
9. HODGKINSON: *J. Soc. Chem. Ind.*, **33**, 445 (1914).
10. MUTHMANN and STÜTZEL: *Ber.*, **32**, 3413 (1899).
11. MOISSAN: *Compt. rend.*, **122**, 357 (1895); **131**, 595 (1900).
12. PETERSSON: *Ber.*, **28**, 2419 (1895).
13. KLEINHEKSEL and KREMERS: *J. Am. Chem. Soc.*, **50**, 959 (1928).
14. HERMANN: *J. prakt. Chem.*, **82**, 385 (1861).
15. BALKE: U. S. patent 1289079; *cf. Chem. Abstr.*, **13**, 773 (1919).
16. HEAP and NEWBERRY: Brit. patent 130626; 131029; *cf. Chem. Abstr.*, **14**, 99, 210 (1920); U. S. patent 1331257; *cf. Chem. Abstr.*, **14**, 1193 (1920); Can. patent 200907; *cf. Chem. Abstr.*, **14**, 2399 (1920).
17. Ger. patent 268827, assigned to *Deut. Gasbühlicht-Akt.-Ges.*; *cf. Chem. Abstr.* **8**, 1861 (1914).
18. BRAUMAN and TAKVORIAN: *Compt. rend.*, **194**, 1579 (1932).
19. AUDRIETH, REED, and SCHMIDT: unpublished observations.
20. REED, HOPKINS, and AUDRIETH: *J. Am. Chem. Soc.*, **57**, 1159 (1935).

* All rare earth material that carries over during the removal of ammonium chloride adheres to the containers or is used for test portions, is readily recovered by solution in dilute nitric acid, precipitation as the oxalate, and ignition to the oxide.

CHAPTER IV

12. CARBON TETRAFLUORIDE

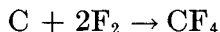

SUBMITTED BY DON M. YOST*

CHECKED BY J. H. SIMONS†

Carbon tetrafluoride is formed by passing gaseous fluorine over finely divided carbon (Norit).¹ Sugar charcoal especially, and some wood charcoals, give large amounts of higher carbon fluorides and are to be avoided if the lower fluorides are desired. Norit seems to be the best when large yields of carbon tetrafluoride are desired.

Procedure

The Norit is placed in a copper reaction tube provided at the ends with an outlet and inlet. A tube 25 cm. long and 2 cm. outer diameter is convenient and the ends may consist of threaded caps equipped with smaller sized copper tubing to serve as outlet and inlet. Solder may be used in making connections. The end of the outlet tube is passed through a two-hole rubber stopper which fits a widemouthed bottle. The bottle contains enough 6N sodium hydroxide to cover the end of the copper tube 0.5 to 1 cm. The sodium hydroxide solution serves to absorb any HF or SiF₄ in the gas stream. Through the other hole of the rubber stopper is fitted a glass outlet tube which leads to a container so arranged that the gas is collected over water. Hydrostatic heads of more than 3 cm. of water should be avoided. Fluorine is passed into the inlet of the copper tube at the rate of 1 to 3 l. per hour. At first, the end of the reaction tube nearest the inlet becomes hot to the touch, and after-

* California Institute of Technology, Pasadena, Calif.

† Pennsylvania State College, State College, Pa.

ward the amount of carbon consumed may be estimated by noting the position of the hottest point.

The resulting gas is dried by passing it over P_2O_5 . The impurities consist principally of C_2F_6 and higher fluorides as well as some O_2 and OF_2 (from unreacted F_2 and NaOH solution). Complete separation of CF_4 from the impurities can be attained by fractional distillation in a modern column.² It is difficult to remove the last traces of C_2F_6 by ampoule-to-ampoule distillation alone. At liquid-air temperatures, the nearly pure substance, as well as the unpurified product, liquefies to a colorless liquid containing varying amounts of a white precipitate (C_2F_6), the amount depending on the purity.

Properties

Pure CF_4 melts at -183.6° and boils at -127.8° . The heat of vaporization is 2947 cal.; and the heat of formation, about 183,500 cal. $S^\circ_{298} \approx 63$ cal. per degree, $\Delta F^\circ_{298} \approx -173,500$ cal. from C and F_2 . The gas is very unreactive. It does not attack glass even at elevated temperatures. It reacts with metallic sodium only when the mixture is heated.

References

1. RUFF and KEIM: *Z. anorg. allgem. Chem.*, **192**, 249 (1930); RUFF and BRETSCHNEIDER, **217**, 1 (1934).
2. BOOTH and BOZARTH: *Ind. Eng. Chem.*, **29**, 470 (1937).

13. TRIOXALATO SALTS

(Trioxalatoaluminate, -ferriate, -chromiate,
and -cobaltiate)



SUBMITTED BY JOHN C. BAILAR, JR.,* AND ELDON M. JONES*

CHECKED BY H. S. BOOTH† AND M. GRENNERT†

Many different types of complex metal oxalates have been described, the best known being the trioxalato salts of the

* University of Illinois, Urbana, Ill.

† Western Reserve University, Cleveland, Ohio.

trivalent metals containing the ion $[M(C_2O_4)_3]'''$, in which M may represent any one of a number of trivalent ions. The amount of water of hydration is variable, but salts containing the same number of molecules of water often form isomorphous series.

Bergmann and Fox¹ have recently shown that potassium trioxalato chromiates and cobaltiates precipitate glycine specifically from mixtures of amino acids.

Of the many methods available for the preparation of the trioxalato salts, a few are illustrated here.

A. POTASSIUM TRIOXALATOALUMINIATE

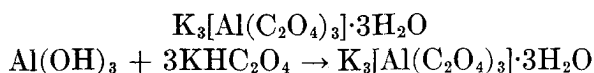

A solution of 67 g. (0.1 mol) of aluminum sulfate, $Al_2(SO_4)_3 \cdot 18H_2O$, is treated with a solution of 24 g. of sodium hydroxide. The precipitated aluminum hydroxide is filtered, washed, and boiled with a solution of 76.8 g. of potassium hydrogen oxalate (or a mixture of 55.2 g. of potassium oxalate monohydrate and 37.8 g. of oxalic acid dihydrate) in about 800 ml. of water. Any aluminum hydroxide which does not dissolve is filtered out and the filtrate is evaporated to crystallization. The yield is nearly quantitative.

B. POTASSIUM TRIOXALATOFERRIATE

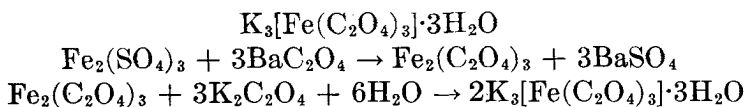

Twenty-five grams of ferric sulfate, 50 g. of barium oxalate (which may be prepared from 50 g. of $BaCl_2 \cdot 2H_2O$ and 29.3 g. of $Na_2C_2O_4$), and 27.3 g. of potassium oxalate monohydrate are placed in 600 ml. of water and digested for several hours on the steam bath. After filtering with suction and washing the precipitate, the filtrate is evapo-

rated to 100 ml. and allowed to cool. The light-green trioxalatoferrate crystallizes in nearly quantitative yield.

Any soluble ferric salt, in the presence of excess oxalate ion, yields the trioxalatoferrate. By using ferric sulfate and barium oxalate the elimination of foreign ions is rendered very easy.

C. POTASSIUM TRIOXALATOCOBALTATE³

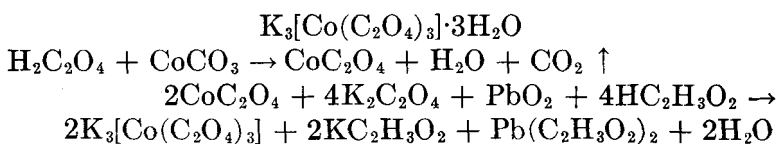

Twenty-three and eight-tenths grams (0.2 mol) of cobalt carbonate is dissolved in a solution of 25.2 g. of oxalic acid ($\text{H}_2\text{C}_2\text{O}_4 \cdot 2\text{H}_2\text{O}$) and 73.7 g. of potassium oxalate ($\text{K}_2\text{C}_2\text{O}_4 \cdot \text{H}_2\text{O}$) in 500 cc. of hot water. When the solution has cooled to 40°C., while it is vigorously stirred, 23.9 g. of lead dioxide (see synthesis 16) is added slowly, followed by 25 ml. of glacial acetic acid added a drop at a time. The stirring is continued for an hour, during which time the color changes from red to deep green. After the unused lead dioxide is filtered out, the trioxalatocobaltate is precipitated by the addition of 500 ml. of alcohol. The material appears as emerald-green needles, which are sensitive to both light and heat. The yield is 70 g. (71 per cent).

D. POTASSIUM TRIOXALATOCHROMIATE²

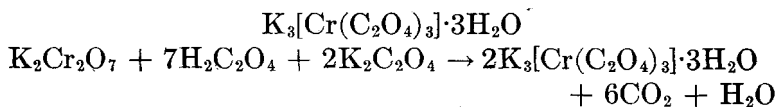

To a solution of 23 g. of potassium oxalate monohydrate and 55 g. of oxalic acid dihydrate in 800 ml. of water is added 19 g. of powdered potassium dichromate in small portions with vigorous stirring. When the reaction is ended, the solution is evaporated nearly to dryness and

allowed to crystallize. Potassium trioxalatochromiate forms deep-green crystals with a brilliant blue iridescence. Yield 45 g. (90 per cent).

References

1. BERGMANN and FOX: *J. Biol. Chem.*, **109**, 317 (1935).
2. GRAHAM: *Ann.*, **29**, 9 (1839).
3. SORENSEN: *Z. anorg. Chem.*, **11**, 2 (1896).

14. SILICOBROMOFORM (TRIBROMOSILANE)

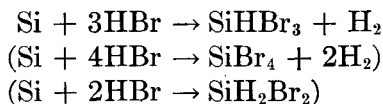

SUBMITTED BY W. C. SCHUMB*
CHECKED BY R. C. YOUNG*

Silicobromoform is usually prepared by passing hydrogen bromide over heated silicon^{1,2,4,5} or a silicide such as copper silicide.³ The product, consisting of a mixture of silicon tetrabromide with a few per cent of tri- and dibromosilanes, is purified by shaking with mercury, if necessary, to remove any free bromine, and by fractional distillation. The use of metal silicides instead of silicon does not add appreciably to the yield of the bromoform and is not recommended in the following procedure.

Procedure

The apparatus is assembled as shown in Fig. 6 and is constructed throughout of pyrex glass. Hydrogen gas is passed through several towers *A* of fused potassium hydroxide,† thence through the rest of the system to sweep out the air. The bubble tube *B* contains bromine, warmed in a water bath to 45°C. The hydrogen when allowed to bubble through the bromine forms a mixture which is passed through the catalyst tube *C* containing platinized

* Massachusetts Institute of Technology, Cambridge, Mass.

† The commercial fused potassium hydroxide is best remelted in a nickel crucible and poured out upon a cold surface (such as a copper sheet), and when solidified and cooled somewhat, is broken up into flakes suitable for charging the absorption towers.

asbestos, which is heated to 200°C. by an electric sleeve (see also synthesis 53).

Leaving *C* the gases consist of hydrogen bromide and hydrogen, together with traces of free bromine, which is removed in the tube *D* containing either ferrous bromide (which has been partially dehydrated at 100°C.) or slightly moistened red phosphorus. The towers *E*, containing freshly fused calcium bromide,* serve to dry the gases before entering the reaction tube *F*, which is filled with crushed commercial silicon (about 40 mesh, averaging 97.5 per cent Si), and is heated in an electric furnace, or sleeve, to a temperature of 360 to 400°C.

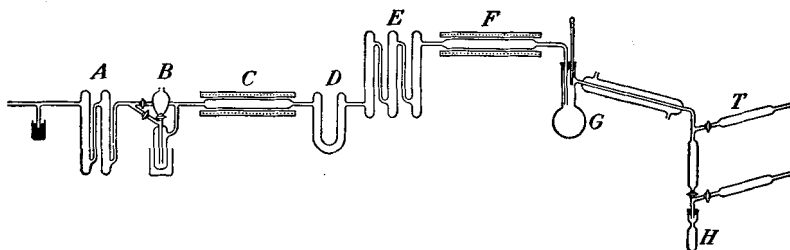

Fig. 6.—Apparatus for synthesis of silicobromoform.

The crude gaseous products are condensed in the flask *G*, which is deeply immersed in a Dewar tube filled with alcohol, cooled to about -30°C . by the addition of solid carbon dioxide. At lower temperatures, solid silicon tetrabromide tends to clog the delivery tube. The unchanged hydrogen bromide and hydrogen pass out of the system through a guard tube *T* of calcium chloride into the hood.

The crude product is twice fractionally distilled; the first distillation is directly from the flask *G* into test tubes *H* which have been drawn down to facilitate sealing. The fractions collected are (1) up to 125°C . and (2) from 125 to 154°C . As a tube (*H*) is filled, manipulation of the stopcocks makes it possible to seal, remove, and replace the

* The calcium bromide and ferrous bromide towers are frequently refilled if much product is to be prepared.

tube with a fresh receiver, which is then evacuated before collecting more of the distillate. These precautions are necessary because of the spontaneously inflammable character of tribromosilane as well as its great tendency to hydrolyze.

The rate of flow of the hydrogen—three or four bubbles per second—is such that about 60 g. of bromine is vaporized in a run of 5 hours, yielding about 57 g. of mixed halides in the crude product. Increase in the rate of flow of hydrogen bromide through the reaction tube and decrease

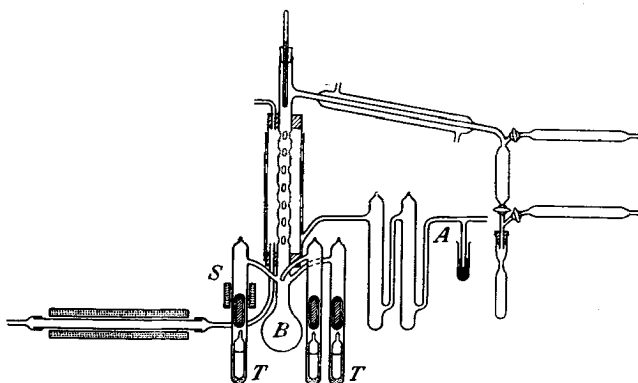

FIG. 7.—Apparatus for purification of silicobromoform.

in the quantity of silicon in the tube favor the formation of increasing proportions of silicon tetrabromide in the products.

The second distillation is carried out conveniently in the apparatus shown in Fig. 7. The Vigreux, or spiral fractionating, column is surrounded with a pyrex air jacket, through which compressed air, preheated to a few degrees below the boiling point of the fraction being collected, is passed.* The air may be preheated conveniently by passage through a porcelain tube contained in an electrically heated sleeve. The sealed tubes *T* containing the fractions from the first distillation are placed on glass-wool

* A suitable vapor-jacketed fractionating column may well be used in place of this arrangement.

cushions at the bottom of the tall vertical tubes, each containing a magnetic hammer (a glass-enclosed iron rod), and the outer tubes are then sealed at the tops. The system is then well evacuated (the walls being cautiously heated meanwhile with a mild flame) to assist in the removal of moisture. The sample tubes are next broken by operation of the solenoid *S*, and the desired fractions distilled into the central bulb *B* which is chilled in a bath of solid carbon dioxide and alcohol. When the desired fractions have been collected in *B*, the vertical tubes may be sealed off near the Vigreux column, and the contents of *B* submitted to fractionation in the manner employed with the crude product described above. The distillation is most conveniently carried out with the system filled with dry nitrogen, admitted through side tube *A*, at atmospheric pressure. Fractions boiling at 64.0, 111.8, and 153.4°C. (corrected) are collected, corresponding to di-, tri-, and tetrabromosilane, respectively; the percentage yield of tribromosilane obtained from the distillation of the crude product is approximately 60 to 70 per cent.

Analytical proof of the purity of silicobromoform is most satisfactorily obtained by measurement of the volume of hydrogen evolved when a weighed sample is decomposed by alkali, the evolved gas being caught in a gas burette attached to the reaction vessel: $\text{SiHBr}_3 + 5\text{NaOH} \rightarrow 3\text{NaBr} + \text{Na}_2\text{SiO}_3 + \text{H}_2 + 2\text{H}_2\text{O}$. Time is allowed for the temperature of the system to become constant, and correction is made for the aqueous tension of the solution and for the vacuum space contained within the capsule. Thus:

0.8588-g. sample gave 71.4 ml. H_2 ; calc. 71.6 ml. (0°C., 760 mm.).

0.5882-g. sample gave 49.5 ml. H_2 ; calc. 49.0 ml. (0°C., 760 mm.).

Such data, in addition to the observed boiling and melting points, furnish a better criterion of purity than the analysis for silicon or bromine, since a small quantity of tetrabromide, if present, will not alter appreciably the percentage composition.

Properties

Silicobromoform is a colorless, mobile liquid, boiling at 111.8°C. and freezing to a white solid melting at -73.5°C. The liquid supercools to a remarkable degree. It is usually spontaneously inflammable when poured through the air. The vapor pressure at 0°C. is 8.8 mm. and may be expressed with an accuracy of a few tenths of a per cent by the equation:

$$\log P = \frac{-1819.5}{T} + 7.6079$$

Cold water completely hydrolyzes it to form silicoformic anhydride, $\text{H}_2\text{Si}_2\text{O}_3$, and HBr .

References

1. BESSON and FOURNIER: *Compt. rend.*, **151**, 1055 (1911).
2. BUFF and WÖHLER: *Liebig's Ann.*, **104**, 99 (1857).
3. COMBES: *Compt. rend.*, **122**, 531 (1896); *Bull. Soc. Chim.*, [3], **7**, 242 (1892).
4. GATTERMAN: *Ber.*, **22**, 193 (1889).
5. SCHUMB and YOUNG: *J. Am. Chem. Soc.*, **52**, 1464 (1930).

15. THE HIGHER CHLORIDES OF SILICON

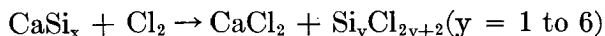

SUBMITTED BY W. C. SCHUMB* AND E. LEE GAMBLE*

CHECKED BY R. C. YOUNG*

Although six members of the homologous series of silicon chlorides, $\text{Si}_y\text{Cl}_{2y+2}$, have been prepared, the first three have proved of greatest interest. Hexachlorodisilane has been prepared in a number of different ways: (1) by the action of silicon tetrachloride on silicon at 1000°C. or more²; (2) by the action of chlorine² and of mercuric chloride³ on hexaiododisilane. (3) A mixture of all the higher chlorides has been prepared by the action of an electric discharge on a mixture of hydrogen and silicon tetrachloride.¹ (4)

* Massachusetts Institute of Technology, Cambridge, Mass.

The most satisfactory way for the preparation of these chlorides has been by the chlorination of silicon alloys, especially of magnesium^{4,5} and iron,⁷ details having been given in the latter case for a large-scale laboratory preparation.

Procedure

Of a number of silicon alloys chlorinated, the one that has proved the most satisfactory is calcium-silicon.* Chlorine, dried by bubbling through concentrated sulfuric acid, is passed into a reaction tube of 34-mm. pyrex glass about 4 ft. long and charged with approximately 250 g. of calcium-silicon broken into small lumps ($\frac{1}{2}$ to $\frac{1}{4}$ in. in diameter) which about half fills the tube. The alloy, on reacting with chlorine, tends to swell and pack the tube so tightly that there is danger of its stopping the flow of chlorine if too much of the alloy is used. The reaction tube is placed on a slope of about 10° , and the end drawn down and sealed to a 1-l. distilling flask, which serves as a receiver. An electric heating coil is placed around the reaction tube and is moved along the tube as the calcium-silicon reacts with the chlorine.

In order to prevent the decomposition of the higher chlorides of silicon, it is very important that only a small part of the reaction tube should be heated at a time. When the chlorine is first passed through the reaction tube, the temperature of the heating coil is about $250^\circ\text{C}.$; when the reaction is well started, it is lowered to about $150^\circ\text{C}.$ The best rate of flow of chlorine is less than two bubbles per second. Under these conditions, in about 12 or 14 days, all the calcium-silicon will be used up, and about 700 ml. of liquid silicon chlorides will be collected.

When the preparation is carried out as described above, keeping the temperature low ($150^\circ\text{C}.$) and the rate of flow of chlorine slow (not over 100 bubbles per minute), a

* The calcium-silicon used was 30 to 35 per cent calcium and was supplied by the Electro-Metallurgical Sales Corporation, Niagara Falls, N. Y.

yield of at least 35 per cent of the chlorides boiling higher than silicon tetrachloride may be obtained; whereas with higher temperatures and faster flow of chlorine, the yield decreases very rapidly. About 65 per cent of the chlorination product is SiCl_4 ; about 30 per cent Si_2Cl_6 ; 4 per cent Si_3Cl_8 ; and 1 per cent $\text{Si}_4\text{Cl}_{10}$, $\text{Si}_5\text{Cl}_{12}$, and $\text{Si}_6\text{Cl}_{14}$. When silicon tetrachloride alone is desired, the yield can be made to approach the theoretical by the use of high temperatures and a faster flow of chlorine.

It is convenient to distill the silicon tetrachloride from the mixture at atmospheric pressure, and this may be done without decomposition of the higher boiling chlorides. The mixture of other chlorides is then distilled under reduced pressure, being divided into three crude fractions: (1) Si_2Cl_6 (2) Si_3Cl_8 , and (3) the residue of $\text{Si}_4\text{Cl}_{10}$, $\text{Si}_5\text{Cl}_{12}$ and $\text{Si}_6\text{Cl}_{14}$ left in the distilling flask. The last is preserved and distilled when combined with as many similar residues as possible. If the last three chlorides are to be obtained in as large amounts as possible, the pressure at which the distillations take place should be quite low, or their decomposition will be excessive (noted by the appearance of a blackish deposit of silicon in the distillation flask). It is necessary to redistill each fraction in order to obtain a pure product. The hexachlorodisilane may be distilled at atmospheric pressure; the others must be distilled under reduced pressure.

Properties

Under ordinary conditions, the chlorides of silicon are colorless liquids, with the exception of $\text{Si}_6\text{Cl}_{14}$, which is a white solid. They all hydrolyze with great ease, fuming with the moisture of the air. When heated, the vapors of the higher chlorides inflame in air.

The boiling points of the homologous series are as follows:⁶ SiCl_4 , 56.9°; Si_2Cl_6 , 147°; Si_3Cl_8 , 216°; $\text{Si}_4\text{Cl}_{10}$, 150° (15 mm.); $\text{Si}_5\text{Cl}_{12}$, 190° (15 mm.); and $\text{Si}_6\text{Cl}_{14}$ sublimes *in vacuo* at 200°.

The vapor pressures of Si_2Cl_6 and Si_3Cl_8 at various temperatures are as follows:⁷

Si_2Cl_6							
P., mm.....	12	20	50	105	130	150	200
Temp., °C.....	40	50	65	84	92	95	102

Si_3Cl_8							
P., mm.....	17	30	60	80	90	110	
Temp., °C.....	100	113	129	139	143	149	

References

1. BESSON and FOURNIER: *Compt. rend.*, **152**, 603 (1911).
2. FRIEDEL: *Compt. rend.*, **73**, 1011 (1871).
3. FRIEDEL and LADENBURG: *Ann.*, **203**, 253 (1880).
4. GATTERMAN and ELLERY: *Ber.*, **32**, 1114 (1899).
5. GATTERMAN and WEINLIG: *Ber.*, **27**, 1943 (1894).
6. MELLOR: *Comp. Treatise on Inorg. and Theoret. Chem.*, **VI**, 971; *Int. Crit. Tables*, Vol. I, p. 162.
7. MARTIN: *J. Chem. Soc.*, **105**, 2836, 2860 (1914); *Ber.*, **45**, 2097 (1912); *ibid.*, **46**, 2442, 3289 (1913).
8. TROOST and HAUTEFEUILLE: *Ann. Chim. Phys.* [5], **7**, 459 (1871).

16. LEAD DIOXIDE

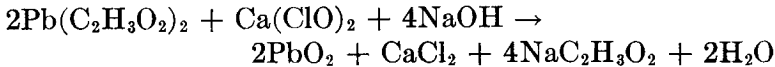

SUBMITTED BY LYMAN C. NEWELL* AND R. N. MAXSON†
CHECKED BY J. P. McREYNOLDS‡

Lead dioxide is widely used as an oxidizing agent in the arts as well as in the laboratory. It reacts with strong bases with the formation of plumbates, M_2PbO_3 , and dissolves in strong acids, presumably forming plumbic salts. It will not react with weaker acids, such as acetic (*cf.* the preparation of lead tetracetate, synthesis 17).

Lead dioxide has been prepared in many ways. Anodic oxidation of lead salts in acid solution gives anhydrous

* Boston University, Boston, Mass., Deceased.

† University of Kentucky, Lexington, Ky.

‡ University of Illinois, Urbana, Ill.

PbO_2 ; whereas in basic solution, a hydrated material, probably H_2PbO_3 , is formed.

Lead dioxide may also be obtained by the action of concentrated nitric acid on plumbous orthoplumbate (red lead). It is most easily obtained, however, by the action of oxidizing agents on plumbous salts in alkaline medium. Hypochlorite is commonly used as the oxidant, but permanganate, sodium peroxide, ferricyanide, and many other oxidizing agents can be used.

Procedure

Solutions of 20 g. of lead acetate in 50 ml. of water and 10 g. of sodium hydroxide in 90 ml. of water are thoroughly stirred together. To the resulting solution is added 80 ml. of hypochlorite solution made by dissolving 14 g. of High Test hypochlorite* in 200 ml. of water and filtering. After thorough stirring, the mixture is heated slowly to the boiling point and allowed to boil for a few minutes. If a test portion (after filtration and treatment with a few drops of hypochlorite) shows that oxidation is incomplete, 10 ml. more of hypochlorite solution may be added, and the solution boiled again. This is repeated until oxidation is complete.

The precipitate is allowed to settle and is washed five or six times by decantation. It is then thoroughly stirred with 50 ml. of 6N nitric acid to remove any calcium plumbite or plumbous hydroxide and is again washed several times by decantation. Finally, it is filtered and allowed to dry. The yield is nearly quantitative.

Properties

Lead dioxide is a brown powder of density between 8.90 and 9.19. When heated above 310°C . it loses half its oxygen yielding the monoxide; but at lower tempera-

* High Test hypochlorite is a special bleaching powder made by the Mathieson Alkali Works, 60 East 42d Street, New York, N. Y., and containing about 65 per cent available chlorine. If it is not obtainable, ordinary bleaching powder may be used, but about twice the quantity is required.

tures, in sunlight, it forms red lead, Pb_3O_4 . It is practically insoluble in water but definitely soluble in mineral acids.

17. LEAD TETRACETATE

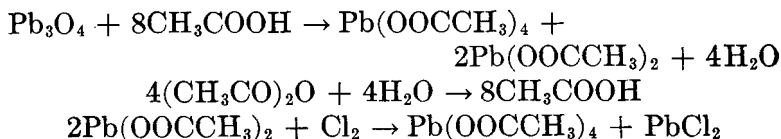

SUBMITTED BY JOHN C. BAILLAR, JR.*

CHECKED BY W. C. FERNELIUS† AND H. A. SKINNER†

As is the case with most salts of higher valence metals, lead tetracetate may be obtained by electrolytic oxidation. This may be done by direct oxidation of the lower acetate¹ or indirectly through the sulfate.² Although the method gives good yields, it is inconvenient. Colson³ has prepared the material by treatment of an acetic acid solution of lead diacetate with chlorine. This results in the formation of equimolecular amounts of lead dichloride and lead tetracetate which are separated by recrystallization from glacial acetic acid. Lead tetracetate is commonly prepared by the method of Dimroth and Schweizer,⁴ which is adapted from the procedures of Hutchinson and Pollard⁵ and of Dimroth, Friedeman, and Kämmerer.⁶ A modification of their method is described here.

Procedure

A 2-l. three-necked flask is fitted with a thermometer and mercury-sealed stirrer. A mixture of 1080 g. of glacial acetic acid and 360 g. of acetic anhydride is placed in the flask, and then, with the stirrer revolving rapidly, 600 g. of dry minium is added. It is best to add the red lead oxide gradually in small portions so that it will not cake. Care should be taken that the temperature does not rise above 65°C. Toward the end of the reaction, it may be necessary

* University of Illinois, Urbana, Ill.

† The Ohio State University, Columbus, Ohio.

to warm the flask cautiously to complete the conversion of the oxide to the acetate. When the material has cooled, the precipitated lead tetracetate is filtered off with suction (through a large funnel, since the solution filters rather slowly) and is washed with glacial acetic acid. The yield is about 300 g.

Another 200 g. of the product may be obtained from the mother liquor following the directions of Colson.³ The liquid is returned to the original flask, heated to 80°C., with stirring, and a stream of dry chlorine passed into it. When the reaction is complete, the solution is filtered while hot, and the precipitated lead chloride is washed with hot glacial acetic acid. On cooling, lead tetracetate is deposited from the filtrate. This second crop is contaminated with lead chloride and must be recrystallized if a pure material is desired.

Properties

Lead tetracetate crystallizes in colorless prisms melting at 175 to 180°C., which are unstable in air. As might be expected, the salt hydrolyzes very readily, forming brown lead dioxide, and it has been suggested that this reaction might be utilized in testing for moisture in gases. Lead tetracetate is somewhat soluble in chloroform, carbon tetrachloride, and benzene; and if the solvents are perfectly dry, the lead tetracetate may be recovered unchanged. Acetic acid dissolves it slightly when cold and readily when warm; and Dimroth and Schweizer⁴ have shown that in acetic acid solution, it can be used as an oxidizing agent for many purposes. Lead tetracetate dissolves in concentrated halogen acids, reacting to form haloplumbic acids, H_2PbX_6 .

References

1. ELBS and RIXON: *Zeit. Elektrochem.*, **9**, 267 (1903).
2. ELBS and FISCHER: *Zeit. Elektrochem.*, **7**, 345 (1900).
3. COLSON: *Bull. soc. chim.*, [3] **31**, 423 (1904).
4. DIMROTH and SCHWEIZER: *Ber.*, **56**, 1375-1385 (1923).

5. HUTCHINSON and POLLARD: *J. Chem. Soc.*, **69**, 221 (1896).

6. DIMROTH, FRIEDEMANN, and KÄMMERER: *Ber.*, **53**, 485 (1920).

18. ANHYDROUS ZIRCONIUM TETRABROMIDE

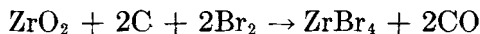

SUBMITTED BY R. C. YOUNG* AND HEWITT G. FLETCHER*

CHECKED BY W. C. FERNELIUS† AND E. W. BOWERMAN‡

Zirconium tetrabromide has been prepared by passing carbon dioxide^{1,2} or nitrogen³ saturated with bromine over a mixture of zirconium dioxide and sugar charcoal or by the action of bromine vapor on zirconium metal,^{4,5} on zirconium carbide⁵ or on zirconium nitride.⁶ The method outlined below follows the general plan of Hönigschmidt, Zintl, and González.³

Procedure

An intimate mixture of 18 g. of zirconium oxide and 80 g. of finely powdered sugar charcoal is spread uniformly in a pyrex tube 90 cm. long and 35 mm. in diameter, from a distance 20 cm. from one end to within 40 cm. of the other, the layer thus extending for 30 cm. A larger pyrex tube, 40 cm. long and 50 mm. in diameter, converted by winding with resistance wire into an electric sleeve furnace capable of maintaining a temperature of 560°C., is used to heat the mixture of charcoal and zirconium oxide. The end of the reaction tube close to the reaction mixture is fitted with a cork stopper† and inlet tube and, through this, dry nitrogen is led into the apparatus as the temperature is gradually raised to 560°C. During this rise of temperature, all the adsorbed water will be driven from the mixture to the outer part of the reaction tube. It is necessary to remove this by heating with a burner.

* Massachusetts Institute of Technology, Cambridge, Mass.

† The Ohio State University, Columbus, Ohio.

‡ The stoppers used are painted with collodion to prevent air and moisture from entering the apparatus.

When the water vapor is completely expelled, the end of the tube is fitted with a cork stopper bearing a straight calcium chloride tube loosely packed to prevent plugging. The nitrogen is now allowed to pass through bromine at the rate of approximately one bubble per second and then is directed into the reaction tube. As the reaction proceeds, a sublimate of zirconium bromide collects in the tube several centimeters beyond the furnace.

The major portion of this sublimate collects in a small section of the tube; and if a plug forms, it may be removed by heating with a free flame that section of the tube in which it occurs. A considerable quantity of the bromide will be carried along in the stream of nitrogen, even through the tube of calcium chloride.*

When the reaction is completed, bromine appears at the end of the apparatus. The time required depends on the rate at which bromine is passed into the reaction tube and is usually 24 hours.

Purification

Dry nitrogen is allowed to pass through the furnace while it cools to room temperature. The crude product, weighing about 42 g., is then transferred to a vacuum sublimation apparatus. This consists of a pyrex tube 20 cm. by 12 mm. fitted with a stopcock at one end and sealed to another tube 20 cm. by 24 mm. at the other. Glass wool is placed at the junction of the tubes. To prevent reaction with the moisture of the air, the entire operation of transferring the crude bromide to the large tube and of sealing the open end is completed as rapidly as possible. In a furnace, in which the temperature is gradually raised to 280°C., and at a pressure of 1 mm. or less, the zirconium bromide will sublime through the layer of glass wool and condense in a compact crystalline mass

* Rapid flow of nitrogen through the apparatus may cause deposition of the bromide in the calcium chloride tube, especially if the latter is packed too tightly.

in that part of the smaller tube which is outside the furnace. About 2 hours is required for the sublimation. A yield of 36 g. is obtained, corresponding to 60 per cent of the theory. Analysis: Calc. for $ZrBr_4$: Zr, 22.20 per cent; Br, 77.79 per cent. Found: Zr, 22.30, 22.33 per cent; Br, 77.68, 77.76 per cent.

Properties

Zirconium tetrabromide is a white microcrystalline salt which is very hygroscopic. It dissolves in water with the liberation of heat, forming zirconyl bromide. The tetrabromide is also soluble in certain organic solvents, such as alcohol and ether. It reacts with ammonia at low temperature to form ammines.

References

1. MELLISS: *Bull. soc. chim.*, **14**, 204 (1870).
2. MATTHEWS: *J. Am. Chem. Soc.*, **20**, 839 (1898).
3. HÖNIGSCHMIDT, ZINTL, and GONZÁLEZ: *Z. anorg. allgem. Chem.*, **139**, 293 (1924).
4. BAILEY: *Chem. News*, **60**, 17 (1889).
5. STÄHLER and DENK: *Ber.*, **38**, 2611 (1905).
6. WEDEKIND: *Z. anorg. Chem.*, **45**, 385 (1905).

19. ANHYDROUS THORIUM BROMIDE

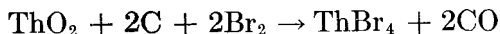

SUBMITTED BY R. C. YOUNG* AND HEWITT G. FLETCHER*

CHECKED BY F. TOIGO† AND W. C. JOHNSON†

The method described below for the preparation of thorium bromide combines the method of Troost and Ouvrard³ with that of Moissan and Martinsen.² The former passed bromine over a heated mixture of thorium dioxide and carbon but did not purify the thorium bromide formed. The latter prepared the halide by the action of bromine on heated thorium carbide and purified the product by sublimation, first in a current of hydrogen and

* Massachusetts Institute of Technology, Cambridge, Mass.

† University of Chicago, Chicago, Ill.

then *in vacuo*. Bourion¹ passed a mixture of hydrogen bromide and sulfur monochloride over heated thoria. Complete experimental details are not given in the foregoing papers.

Procedure

The preparation of thorium bromide is carried out in a silica tube about 45 cm. long and 4 cm. in internal diameter, which has been converted by winding with resistance wire (leaving 7.5 cm. of tube bare at each end) into an electric furnace capable of maintaining a temperature of 900°. Intimately mix 40 g. of thorium dioxide in powder form with 80 g. of finely powdered sugar charcoal. Distribute this mixture evenly in the tube within the range of the heated part, leaving a space above the reacting materials equal to about one-fourth of the total. A large space is needed for sublimation and to prevent a plug forming towards the cool end of the tube.

Pass dry nitrogen into the apparatus and gradually raise the temperature of the furnace to 800 to 900°C. During this rise in temperature, all the adsorbed water will be driven from the thorium dioxide and charcoal. After water vapor has ceased to be expelled, fit the end of the tube with a cork stopper through which passes a tube 20 cm. long and 20 mm. in diameter, with the outer end drawn down to about 12 mm. and connected to a horizontal calcium chloride tube. Paint both cork stoppers thoroughly with collodion or other protective coating to prevent air and moisture from passing into the reaction tube. Now allow the nitrogen to pass through bromine at the rate of approximately one bubble per second before entering the furnace.

Considerable thorium bromide is carried along with the nitrogen, even through the protecting tube of calcium chloride, if the flow of nitrogen through the apparatus is too fast. As the reaction proceeds, the thorium bromide collects at the end of the silica tube as a powder and in large

crystalline masses. After the completion of the reaction, bromine will appear in the calcium chloride tube. The time required is usually at least 24 hours.

Purification

After the furnace has cooled to room temperature, with the nitrogen still passing through, transfer the crude product weighing about 70 g. to an apparatus for sublimation *in vacuo*. This consists of a pyrex tube 20 cm. long and 24 mm. in diameter, at one end of which is sealed a pyrex tube with stopcock, 20 cm. long and 12 mm. in diameter; glass wool is placed at the junction of the two tubes. To prevent hydration, the entire operation of transferring the crude bromide to the large tube and of sealing it is completed as quickly as possible. On hydration, thorium bromide greatly increases in volume, and a cracked tube may result if sufficient of the salt has accumulated in one place and hydration occurs. In a furnace, at a temperature of approximately 550° and at a pressure of 1 mm. or less obtained with a vacuum pump, sublime the thorium bromide through the glass wool into the smaller tube, and collect as a white crystalline compact mass. About 3 hours is required for the sublimation. A yield of 50 g. is obtained, which corresponds to about 60 per cent of the theory.

Thorium, calc. 42.06%; found 41.96, 42.10%.

Bromine, calc. 57.93%; found 57.91, 57.63%.

Properties

Thorium bromide is a white crystalline solid the density of which is about 5.6. It is hygroscopic and is very soluble in water and in certain organic liquids such as ethyl alcohol and ethyl acetate. It is attacked by fluorine and, when heated, by chlorine and by oxygen. On exposure to light, it is attacked by oxygen.

Thorium bromide is hydrolyzed in water, but it is possible to obtain hydrates of the salt by the evaporation of aqueous

solutions to which hydrobromic acid has been added. Hydrates containing 12, 10, 8, and 7 mols of water per mol of salt have been described.^{4,5,6}

To obtain the oxybromide ThOBr_2 , it is necessary to evaporate a solution of the tetrabromide to dryness and heat the residue to approximately 160°C .²

Thorium bromide is insoluble in liquid ammonia but forms the molecular compounds containing, respectively, per mol of bromide, 20, 14, 10, and 3 mols of ammonia.^{7,8}

References

1. BOURION: *Compt. rend.*, **145**, 245 (1907).
2. MOISSAN and MARTINSEN: *Compt. rend.*, **140**, 1513 (1905).
3. TROOST and OUVARD: *Ann. chim. phys.*, [6] **17**, 229 (1889).
4. CHAUVENET: *Compt. rend.*, **149**, 289 (1909).
5. JANNASCH *et al.*, *Z. anorg. Chem.*, **5**, 283 (1894).
6. ROSENHEIM and SCHILLING: *Ber.*, **33**, 977 (1900); ROSENHEIM, SAMTER, and DAVIDSOHN: *Z. anorg. Chem.*, **35**, 424 (1903).
7. YOUNG: *J. Am. Chem. Soc.*, **57**, 997 (1935).
8. MATTHEWS: *J. Am. Chem. Soc.*, **20**, 815 839 (1898).

CHAPTER V

20. NITROSYL CHLORIDE

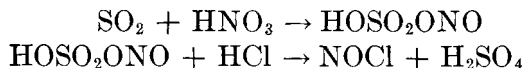

SUBMITTED BY GEORGE H. COLEMAN,* GERALD A. LILLIS,* AND GILBERT E. GOHEEN*

CHECKED BY C. V. HERRMANN† AND H. S. BOOTH†

Nitrosyl chloride has been prepared by passing nitrogen dioxide through moist potassium chloride,¹ by the reaction of nitric oxide with chlorine,² from nitrosylsulfuric acid and sodium chloride,³ and from nitrosylsulfuric acid and dry hydrogen chloride.⁴

The procedure described here is a modification of the last method. The reactants used can be prepared easily, and the principal impurity in the crude product is hydrogen chloride from which nitrosyl chloride can be separated readily.

Procedure

It is necessary to carry out the preparation under a hood. About 200 ml. of fuming nitric acid‡ (sp. gr. 1.60) contained in a 350-ml. tube (test-tube shape) is cooled with ice and salt, and sulfur dioxide is passed into it fairly rapidly. The reaction is exothermic, and the rate of addition should be such that the temperature of the solution *does not rise above 5°C.* In 6 or 8 hours, the crystals of nitrosylsulfuric acid fill the space of the original liquid, forming a compact mass with a layer of dark fuming liquid 2 to 3 cm.

* University of Iowa, Iowa City, Iowa.

† Western Reserve University, Cleveland, Ohio.

‡ Nitrogen dioxide appears to be necessary to catalyze this reaction. In the absence of nitrogen dioxide fumes, the reaction may be delayed and then proceed so rapidly as to be of explosive violence.

deep above it. The tube carrying sulfur dioxide is then removed, and the dark liquid on top is decanted. The crystals together with the small amount of liquid surrounding them are transferred while still cold to a 500-ml. distilling flask, and 35 ml. of concentrated sulfuric acid added.

The flask is fitted with a cork covered with acid-proof lacquer and bearing a glass tube which reaches nearly to the bottom of the flask. A stream of air, dried by passing through calcium chloride and then through concentrated sulfuric acid, is bubbled rapidly through the mixture by connecting a water suction pump to the side arm of the flask, glass or acid-proof tubing being used so far as possible. Removal of the oxides of nitrogen is hastened by having a small bulb blown on the lower end of the tube and several small holes made in the bulb. A water bath is placed about the flask, and the temperature gradually raised to the boiling point (30 to 40 minutes). The passage of air through the hot liquid is continued until the oxides of nitrogen disappear from the flask and for about one hour longer. This usually requires three or four hours.

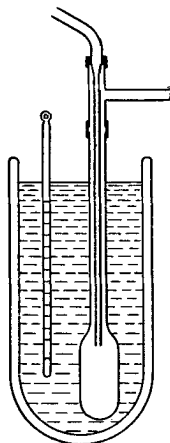

FIG. 8.—Receiver for nitrosyl chloride.

The flask and water bath are allowed to cool to about 55°C ., and the side arm of the flask is attached to the receiver illustrated in Fig. 8. This consists of a bulb of about 35 ml. capacity sealed to a glass tube about 8 mm. in diameter which serves as a condenser and is convenient for sealing when the preparation is complete. The delivery tube and receiver are connected through a T tube by means of short lengths of rubber tubing. The outlet is attached to a calcium chloride tube to prevent moist air from entering the receiver. The receiver is surrounded with acetone cooled to -45°C . by the addition of solid carbon dioxide. Dry hydrogen chloride is then passed into the solution

through the tube used for air at the rate of about 300 bubbles per minute. About 30 ml. of nitrosyl chloride is collected in the receiver in 2 hours. An additional hour yields 3 to 4 ml. more.

The product contains considerable hydrogen chloride. It is transferred to a cold round-bottom flask which is attached to a fractionating column as illustrated in Fig. 9.

The column is surrounded with acetone and dry ice at $-45^{\circ}\text{C}.$ * A receiver of the type previously used is attached to the side arm of the fractionating column. Care should be exercised to exclude moisture from the system. A water bath containing water at $20^{\circ}\text{C}.$ is placed about the flask, and the nitrosyl chloride refluxed for about 30 minutes. Nearly all of the hydrogen chloride is driven off. The temperature of the bath surrounding the column is then raised to about $-5^{\circ}\text{C}.$ by removing some of the cold acetone and adding warm acetone. The nitrosyl chloride begins to distill. As soon as a first fraction

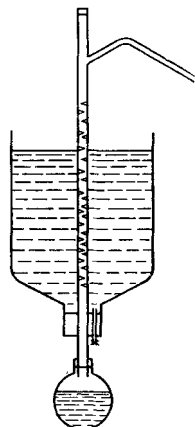

FIG. 9.—Column for purification of nitrosyl chloride.

of 3 to 4 ml. has been collected,† the distilling flask is cooled momentarily, receivers are changed, and the remainder of the product distilled. During the distillation, the temperature of the bath around the column is maintained at $-5^{\circ}\text{C}.$ About 27 ml. of nearly pure nitrosyl chloride is obtained. If for certain uses a product of greater purity is required, a second distillation can be carried out with very little loss.

Analysis

Samples are taken in glass bulbs about 1 cm. in diameter blown on the ends of long narrow glass tubes. The weighed

* A 2-l. bottle from which the bottom has been removed may be used for the bath around the fractionating column.

† The first fraction of 3 to 4 ml. may be added to the crude product obtained in the next run.

bulb is filled by the aid of a vacuum with the cold nitrosyl chloride.* The tube is sealed off, leaving about 18 cm. attached to the bulb, the sealed end being drawn out to a small capillary. The bulb and contents together with the detached piece of glass tube are weighed at room temperature. The bulb is immersed in a bath of acetone and dry ice at approximately the temperature at which it was sealed, and the tip of the capillary broken off under the surface of 35 to 40 ml. of 2N potassium hydroxide solution.† The nitrosyl chloride is allowed to distill slowly into the potassium hydroxide solution. When all has distilled, the bulb is cooled in order to draw some of the solution into the bulb. It is then carefully broken in a beaker, the pieces washed by decantation, and all solutions combined. The solution is neutralized with nitric acid, and the chlorine determined by any suitable method.

Properties

Nitrosyl chloride is a yellow gas or a cherry-red liquid boiling at $-5.5^{\circ}\text{C}.$,^{6,7} or a light blood-red solid melting at $-61.5^{\circ}\text{C}.$ ^{7,1} The density of the gas is 2.99 g. per liter;⁸ and of the liquid, 1.417 ($-12^{\circ}\text{C}.$).⁹ It is decomposed by water and is soluble in fuming sulfuric acid. Vapor-pressure data: 55 mm. at $-68.6^{\circ}\text{C}.$, 630 mm. at $-11.5^{\circ}\text{C}.$, and 1700 mm. at $+15^{\circ}\text{C}.$ ⁶ Its critical temperature is given as $167^{\circ}\text{C}.$, and critical pressure 92.4 atm.⁶ It is somewhat photosensitive.¹⁰

* Before filling the sample bulb, the tube is heated in a small flame about 6 cm. from the bulb and bent through an angle of about $140^{\circ}\text{C}.$ The open end of the tube is then placed below the surface of the cold nitrosyl chloride, an arrangement similar to the receiver illustrated in Fig. 8 being used. By alternately applying and releasing a vacuum and by cooling the bulb with acetone and dry ice, it may easily be filled.

† A 50-ml. cylinder is used for the potassium hydroxide in order that the nitrosyl chloride may be introduced 10 to 15 cm. below the surface. In the reaction, some nitric oxide is evolved. The nitrogen of nitrosyl chloride therefore cannot be determined in this solution.⁵

References

1. WHITTAKER, LUNDSTROM, and MERZ: *Ind. Eng. Chem.*, **23**, 1410 (1931).
2. TAYLOR and DENSLOW: *J. Phys. Chem.*, **31**, 374 (1927).
3. GIRARD and PABST: *Bull. soc. chim.*, [2], **30**, 531 (1878).
4. SCOTT and JOHNSON: *J. Phys. Chem.*, **33**, 1975 (1929).
5. PERRET and PERROT: *Compt. rend.*, **193**, 937 (1931).
6. BRINER and PYLKOFF: *J. chim. phys.*, **10**, 640 (1912).
7. TRAUTZ and GERWIG: *Z. anorg. allgem. Chem.*, **134**, 409 (1924).
8. WOURTZEL: *Compt. rend.*, **155**, 152 (1912).
9. Int. Crit. Tables, Vol. I, p. 108.
10. BOWEN and SHARP: *J. Chem. Soc.*, **127**, 1026 (1925).

21. MONOCHLOROAMINE

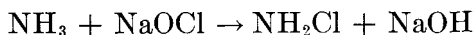

SUBMITTED BY GEORGE H. COLEMAN* AND HERBERT L. JOHNSON*
CHECKED BY W. C. FERNELIUS† AND ARNOLD E. PAVLISH†

Monochloroamine has frequently been prepared in aqueous solution by mixing ammonia and hypochlorite solutions.^{3,5,7} It has been prepared in non-aqueous solution by extraction of aqueous solutions either as directly prepared from hypochlorite or after concentration by distillation under reduced pressure.^{2,6}

The following procedure is given for the preparation of an ethereal solution of monochloroamine. Although the use of solid carbon dioxide around the receiver during the distillation does not greatly increase the amount of monochloroamine obtained, it does make possible the preparation of a more concentrated solution.

Procedure

Connect a 2-l. reaction flask to a coil condenser by means of a glass tube 10 to 12 mm. in diameter, as illustrated in Fig. 10. Fill the jacket around the coil condenser with ice and water. To the lower end of the condenser attach a short adapter (35 mm. in diameter) passing into the receiver. The latter is a 500-ml. pyrex extraction flask with a neck about 45 mm. in diameter. Add 250 ml. of

* University of Iowa, Iowa City, Iowa.

† The Ohio State University, Columbus, Ohio.

diethyl ether to the receiver, and place the lower end of the adapter about 20 mm. above the surface of the ether.

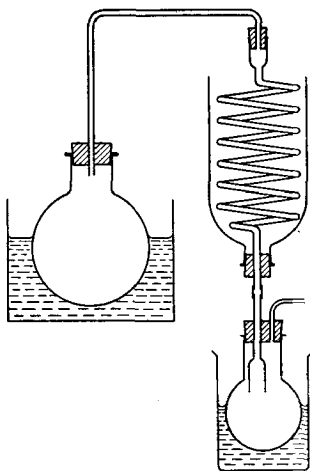

FIG. 10.—Still for monochloroamine.

The width and position of the adapter are such as to prevent clogging with ice. Surround the receiver with a bath of acetone and solid carbon dioxide contained in a 1500-ml. insulated beaker.* Connect the outlet tube from the receiver with a water vacuum pump and manometer.

In the 2-l. reaction flask place 550 ml. of a 1.5 molar aqueous solution of ammonia. This solution need not be *exactly* 1.5 molar, but its *exact* concentration must be known so that a volume equivalent to 550 ml. of 1.5 molar ammonia may be used. Cool this solution to 0°, and add 100 g. of cracked ice and 575 ml. of a 1.5 molar solution of sodium hypochlorite.† Immediately attach the flask to the apparatus, and start the vacuum pump. A pressure

* If solid carbon dioxide is not available, surround the receiver with a mixture of ice and salt. In this case, it is unnecessary to use a wide adapter and extraction flask. Place no ether in the receiver, and collect about 200 g. of distillate. Add about 200 ml. of cold ether to the ice in the receiver. As soon as the ice melts, separate the layers and extract the aqueous solution with two 100-ml. portions of cold ether. Combine the three extracts, dry with calcium chloride, and filter. The volume of the solution will be 325 to 350 ml. It usually contains about 0.24 mol of monochloroamine.

† To prepare an approximately 1.5 molar solution of sodium hypochlorite, dissolve 80 g. (a little more than the calculated weight) of sodium hydroxide in about 200 ml. of water, cool the solution in an ice and salt bath, add 200 g. of cracked ice, and pass chlorine into the solution. Continue the addition of chlorine until the calculated weight has been added or until the yellow precipitate of mercuric oxide formed by adding a little mercuric chloride to the alkaline solution just disappears. Then make the solution slightly alkaline with sodium hydroxide, using a little more mercuric chloride as indicator if necessary. The pH may also be determined by the use of powdered phenolphthalein as described by Cullen and Austin.⁴ Dilute the solution to 600 ml., and determine the exact concentration by titration

between 15 and 25 mm. is desirable.* Heat a water bath to 40 to 45°C., and place around the reaction flask. Maintain this temperature throughout the distillation. Under these conditions, 150 to 175 g. of ice will collect in the receiver in 50 to 60 minutes.

At the end of this time, stop the distillation, and at once decant the ether in the receiver from the ice into a container that is surrounded with acetone and dry ice.† The decanted ether (160 to 170 ml.) contains about 0.18 mol of monochloroamine. Add about 70 ml. of ether to the receiver which still contains the ice. Melt the ice by immersing the flask in warm water (not above 40°C.). When the ice has just melted and while the solution is still cold, separate the ether from the water. This solution contains about 0.07 mol of monochloroamine. Dry by immersing for a few minutes in an acetone and dry-ice mixture, and filter through a plug of cotton. Add this to the first monochloroamine solution. The final volume (230 to 250 ml.) usually contains 0.25 mol or more of monochloroamine.

Properties

If kept cold, the solution is stable for several hours. According to Marckwald and Wille,⁶ monochloroamine has approximately the same solubility in water as in ether. It is less soluble in most other common organic solvents.

with standard sodium thiosulfate solution in the usual way. One milliliter of 1.5 molar hypochlorite solution is equivalent to 30 ml. of 0.1N thiosulfate solution. Use a volume of the hypochlorite solution equivalent to 575 ml. of 1.5 molar solution. If commercial hypochlorite solution is available, dilute to about 1.5 molar concentration, and adjust the pH value as indicated. A convenient method for the preparation of sodium hypochlorite solution is described by Hauser, Gillaspie, and Le Maistre.⁵

* If the distillation pressure is above 25 mm., raise the temperature of the water bath sufficiently to cause the distillation of at least 150 g. within 60 minutes. Lower yields may result with pressures above 25 mm.

† A convenient container for the monochloroamine solution is a large tube 4 to 5 cm. in diameter and 30 to 35 cm. deep. This may be calibrated and used as a measuring cylinder. It fits easily into a wide-necked quart Dewar flask.

Analysis

By means of a pipette add 5 ml. of the monochloroamine solution to a small flask containing 25 ml. of a cold sodium bisulfite solution. A moderate excess of sulfite is necessary. Stopper the flask, and shake gently. When the reaction is complete, remove the ether with a separatory funnel or by warming. Dilute the sulfite solution to 100 ml., and use aliquot portions for the determination of nitrogen and chlorine.

For nitrogen, dilute 25 ml. with about 100 ml. of water, add excess sodium hydroxide, and determine the ammonia by distillation into standard acid.

Determine chlorine in a 25-ml. portion also. Add about 2 ml. of 6N nitric acid, and oxidize the excess sulfite exactly by the addition of a 1 per cent solution of potassium permanganate. Then determine chlorine by the Volhard method or any other that may be convenient. Several methods have been described for the analysis of nitrogen trichloride, which may also be used for monochloroamine.¹

References

1. COLEMAN, BUCHANAN, and PAXON: *J. Am. Chem. Soc.*, **55**, 3669 (1933).
2. COLEMAN and HAUSER: *J. Am. Chem. Soc.*, **50**, 1193 (1928).
3. CROSS, BEVAN, and BACON: *J. Chem. Soc.*, **97**, 2404 (1910).
4. CULLEN and AUSTIN: *J. Biol. Chem.*, **34**, 553 (1918).
5. HAUSER, GILLASPIE, and LE MAISTRE: *J. Am. Chem. Soc.*, **57**, 567 (1935).
6. MARCKWALD and WILLE: *Ber.*, **56**, 1319 (1923).
7. RASCHIG: *Ber.*, **40**, 4586 (1907).

22. DIBROMOAMINE



SUBMITTED BY GEORGE H. COLEMAN* AND GILBERT E. GOHEEN*

CHECKED BY R. C. HESSELBART† AND W. C. FERNELIUS†

Dibromoamine¹ has been prepared in ether solution by passing a slight excess of ammonia into a cold ethereal solution of bromine. The rapid removal of excess ammonia at

* University of Iowa, Iowa City, Iowa.

† The Ohio State University, Columbus, Ohio.

a relatively low temperature is one of the principal difficulties. The following procedure is a slight modification of this method.

Procedure

To 500 ml. of anhydrous ether in a tube of 700 ml. capacity cooled to -50°C . by a mixture of dry ice and acetone in a Dewar flask add 10 ml. of bromine. Pass dry ammonia gas slowly into the solution until the red color turns to

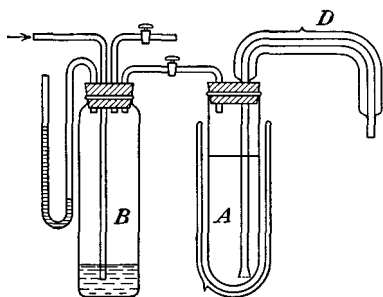

FIG. 11.—Apparatus for separating ammonium bromide from the solution of dibromoamine.

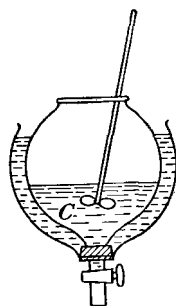

FIG. 12.—Apparatus for removing ammonia from dibromoamine.

yellow (about one hour) and then for two or three minutes longer to provide a slight excess. During this addition, keep the temperature of the mixture at -40 to -50°C . The reaction requires a total of 8 to 8.5 l. of ammonia measured under atmospheric pressure.

To separate the solution of dibromoamine from the solid ammonium bromide, assemble an apparatus as illustrated in Fig. 11. The tube *A* which is immersed in dry ice and acetone contains the reaction mixture. The upper part of tube *D* is vacuum jacketed while the enlarged and perforated lower end extends nearly to the bottom of tube *A*. Tie a filter paper over the lower end of tube *D*, and filter by applying air pressure to the surface of the liquid. This pressure may be obtained and easily regulated by allowing water to run into bottle *B*. Collect the filtered solution in a flask or tube cooled to about -70°C .

For removal of excess ammonia, assemble an apparatus as shown in Fig. 12. This consists of a separatory funnel *C* of about 1200 ml. capacity with a large opening at the top and surrounded by a jacket. Dissolve 190 g. of ordinary granular anhydrous calcium chloride in 440 ml. of water, and place about 150 ml. of this solution (sp. gr. 1.27 to 1.28) in the funnel. Place acetone in the outer jacket, and add dry ice until the solution is cooled to -25°C .

Rapidly pour the cold ethereal solution into the calcium chloride solution while stirring the latter vigorously with a mechanical stirrer. Continue the stirring for about 45 seconds, and stop. As soon as the two layers have separated, draw off the aqueous layer as completely as possible, and immediately draw the ethereal solution containing the dibromoamine into a flask or tube that is surrounded with dry ice and acetone (temperature about -70°C .)^{*} Any water separates in the form of ice which may be removed by filtering in the same apparatus used for removing ammonium bromide. The solution thus prepared contains about 0.045 mol of dibromoamine in 350 ml.

Analysis

Withdraw 5-ml. samples by means of a previously cooled pipette, and add each to 15 ml. of a cold molar sodium bisulfite solution covered with 15 ml. of ether.[†]

Shake the small flask containing the sample for a few minutes to complete the reaction. Remove the ether layer

^{*} The removal of the excess ammonia should be accomplished within two or three minutes, and the temperature of the solution kept as low as possible to avoid decomposition of a part of the dibromoamine and a resulting increase in the bromine:nitrogen ratio.

[†] If the solution is slightly turbid as the result of a little ice or ammonium bromide, take samples in the following manner: Tie filter paper over one end of a glass tube about 2 cm. in diameter. Cool this in ether at -70°C ., and lower into the dibromoamine solution. When several milliliters of the solution have filtered in, lift the tube, and pour the contents back. Immediately lower the tube again, and, when a sufficient quantity has filtered into the tube, take samples.

with a small separatory funnel, and wash with small portions of water. Combine all aqueous layers.

Determine nitrogen by transferring the solution to a distilling flask, adding excess sodium hydroxide, and distilling the ammonia into standard acid.

For the determination of bromine, acidify with dilute nitric acid a sample treated as just described, oxidize the excess bisulfite with 1 per cent potassium permanganate solution, and determine the halogen by the Volhard or another suitable method. The bromine:nitrogen ratio usually varies from 1.97 to 2.02.

Properties

Ethereal solutions of dibromoamine are stable at -70°C . for one hour or longer but decompose rather rapidly at 0°C . or at higher temperatures. The solution has a straw-yellow color and a sharp irritating odor.

Reference

1. COLEMAN, YAGER, and SOROOS: *J. Am. Chem. Soc.*, **56**, 965 (1934).

23. NITROGEN TRICHLORIDE



SUBMITTED BY WILLIAM A. NOYES*

CHECKED BY GEORGE H. COLEMAN† AND GILBERT E. GOHEEN†

Nitrogen trichloride was first prepared by Dulong¹ in 1811 by the action of chlorine gas upon a solution of an ammonium salt. It may also be obtained by the action of hypochlorous acid upon an ammonium salt.² Hentschel³ prepared it in benzene solution by extracting the aqueous reaction mixture of calcium hypochlorite and ammonium chloride with benzene.

The pure anhydrous compound may be prepared by passing chlorine into a serpentine tube containing a solution of ammonium sulfate, carrying the volatile compound

* University of Illinois, Urbana, Ill.

† State University of Iowa, Iowa City, Iowa.

through a wash bottle containing concentrated sulfuric acid, and condensing it with a freezing mixture.⁴

The present method involves the action of chlorine upon an ammonium sulfate solution accompanied by extraction of the product from the aqueous solution. Solutions of nitrogen chloride (up to 20 per cent) in various solvents may be prepared without fear of explosion.³ The method here described is a reasonably safe one and has been used repeatedly without accident by a number of workers. However, the extremely explosive character of nitrogen trichloride should always be borne in mind. It is advisable, therefore, to carry out the preparation behind a safety screen.

Procedure

In a 1-l. round-bottomed flask equipped with a stirrer and a glass tube reaching nearly to the bottom of the flask are placed 240 g. of carbon tetrachloride,* 60 g. of ammonium sulfate,† and 600 ml. of water. The flask is surrounded with cold water (about 10°C.), stirring is begun, and chlorine is led into the mixture. (**Caution! Hood!**) The addition of chlorine may be completed in 40 to 60 minutes.

The acid ammonium sulfate solution is poured off, and the carbon tetrachloride layer transferred to a 1-l. separatory funnel. Three hundred milliliters of 5 per cent ammonium sulfate solution is added to the funnel, and the mixture shaken vigorously for 5 minutes. The two layers are separated, and the operation repeated. The final carbon tetrachloride solution weighs about 270 g. and contains about 12 per cent of nitrogen trichloride which is practically free from excess chlorine. The solution may be dried with a little calcium chloride and filtered.

* If it is desirable to use the final solution at -80°C ., it should contain 10 to 20 per cent of chloroform to lower the melting point.

† Since the reaction between ammonium chloride and chlorine is reversible, ammonium sulfate is much more suitable. Shaking with a fresh solution of ammonium sulfate completes the reaction in the desired direction.⁵

Analysis

A sample of 0.3 to 0.5 g. of the solution is weighed in a small U tube having a capacity of 1 ml. or less and drawn out to a fine capillary on one side. The solution is transferred to *A* of the double U tube shown in Fig. 13. This contains 2 ml. of concentrated hydrochloric acid; and *B*, 0.5 ml. of water. The acid decomposes the trichloride quantitatively to ammonium chloride and chlorine. With a slow current of air the chlorine is driven over into 15 ml. of a 10 per cent solution of potassium iodide into which *C* dips, and the liberated iodine is titrated with 0.1N sodium thio-sulfate. The disappearance of the yellow color of the iodine solution serves as an indicator.

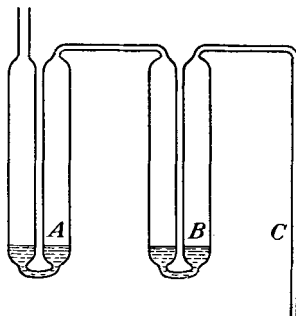
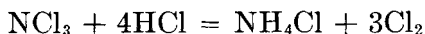

FIG. 13.—U tube for quantitative determination of nitrogen trichloride.

The hydrochloric acid solution containing ammonium chloride is transferred to a flask, an excess of potassium hydroxide added, and the ammonia distilled and collected in 0.1N hydrochloric acid. The equation is



If the trichloride is pure, the volume of the thiosulfate will be six times the volume of the 0.1N hydrochloric acid. Any excess of thiosulfate will indicate that the trichloride contained some free chlorine and will be a measure of the amount.

References

1. DULONG: *Ann. chim. phys.*, [1] **86**, 37 (1813).
2. BALARD: *Ann. chim. phys.*, [2] **57**, 258 (1834).
3. HENTSCHEL: *Ber.*, **30**, 1792, 2642 (1897).
4. NOYES: *J. Am. Chem. Soc.*, **42**, 2173 (1920).
5. NOYES: *ibid.*, **50**, 2902 (1928).

24. NITRAMIDE

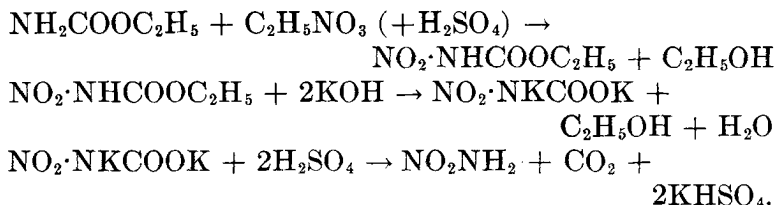

SUBMITTED BY C. A. MARLIES,* V. K. LA MER,* AND JOSEPH GREENSPAN*
CHECKED BY W. A. SHINE† AND L. F. AUDRIETH†

The method employed is essentially the same as that first proposed by Thiele and Lachman¹ but has been modified in several details, the most important change involving the manner of extracting² the nitramide from aqueous solution. The purity and yields are markedly affected by slight changes in procedure; consequently exact directions are given in considerable detail. Potassium nitrocarbamate and nitramide are best made under conditions of low temperature and low humidity. Contact with cork and rubber should be avoided wherever possible.

Procedure

Since the nitramide is obtained as a product of an evaporation, all impurities will concentrate in the final product. Materials employed must therefore be of high purity. The solvents must be purified and meet the specifications outlined below.

a. Ethyl Ether, Alcohol-free. The synthetic product is satisfactory after filtration to remove mechanical contaminants. The solvent should be stored in a glass-stoppered bottle.

b. Ethyl Ether, Anhydrous. The anhydrous ethyl ether of commerce may be dried first over calcium chloride to remove alcohol and then over sodium. After removal of

* Columbia University, New York, N. Y.

† University of Illinois, Urbana, Ill.

these agents the solvent is distilled, preferably in an all-glass apparatus.

c. Petroleum Ether, Low Boiling. Commercial isopentane is satisfactory after distillation to remove heavy ends and mechanical contaminants. If this product is not available, the commercial low-boiling product may be distilled, and the fraction boiling over the range 26 to 30° used.

d. Methanol, Synthetic. An aldehyde-free material is prepared by refluxing the alcohol for 2 hours with granular aluminum and potassium hydroxide, followed by distillation of the alcohol from the reaction flask. Five to ten grams of aluminum and eight to ten grams of potassium hydroxide are used for each liter of alcohol treated in this manner.³

A. AMMONIUM NITROURETHANE

In a 1-l. beaker immersed in an ice-salt bath, 500 ml. of concentrated sulfuric acid is cooled to 0°C. One hundred grams of ethyl carbamate is added, and the mixture stirred* until a homogeneous solution is obtained.

The solution is cooled to -5°C., and 110 g. (100 ml.) of ethyl nitrate is added. The mixture is agitated for 1½ hours. It is then poured slowly over 1.5 kg. of cracked ice, being stirred continuously. The solution is extracted six times with 200-ml. portions of U.S.P. ethyl ether in a large separatory funnel. The ethereal solution contains the nitrourethane together with a considerable quantity of impurities.

One hundred milliliters concentrated ammonium hydroxide is diluted with 200 ml. water, and 100 g. finely cracked ice is added. The combined ethereal extracts are poured over this mixture slowly with continuous stirring. The aqueous layer, which must be alkaline to litmus, is drawn

* The ice-salt bath used by Archibald⁴ will be found convenient. The stirrer should be of the type used for agitating immiscible liquids, preferably constructed to draw in the top layer and eject it at the bottom.⁵

off; the ether layer is further extracted four times with 200-ml. portions of 0.5 molar ammonium hydroxide. The combined ammonium hydroxide extracts now contain the purified nitrourethane in the form of its ammonium salt.*

A mixture of 100 ml. of concentrated sulfuric acid and 300 g. of cracked ice is now added to the foregoing ammoniacal solution; the resultant solution must be acid to Congo red. It is extracted six times with 200-ml. portions of alcohol-free ether, and the combined ethereal extracts are dried over anhydrous calcium chloride. This operation further purifies the nitrourethane which is then again converted to the ammonium salt.

The ether solution of nitrourethane is filtered into a 4-l. flask or beaker and is diluted to 3 l. with anhydrous alcohol-free ether. The solution is then saturated with dry ammonia gas or treated with an excess of liquid ammonia, thereby precipitating ammonium nitrourethane. The product is filtered on a large Büchner funnel, washed with a small quantity of alcohol-free ether,† and dried by drawing air through the filter cake. Theoretical yield 170 g.; actual yield 80 to 95 g. (47 to 55 per cent of theory).

Ammonium nitrourethane is a white, crystalline solid and is quite stable in air. It may, therefore, be prepared in large quantity and stored at room temperature in an ordinary bottle.

B. POTASSIUM NITROCARBAMATE

Five hundred grams of potassium hydroxide is dissolved in 2 l. of purified methanol. The insoluble material is allowed to settle, and 1500 ml. of this solution is poured into a 3-l. beaker. The solution is cooled to 0 to 3°C.

Fifty grams of powdered ammonium nitrourethane is added to a mixture of 100 ml. of water and 100 ml. of

* The ether layer may be used again for the same purpose after simple distillation.

† The ether filtrate and washings may be used again for the same purpose after distillation.

methanol. The solution and excess solute are cooled to 5°C. and then poured into the cooled potassium hydroxide-methanol solution, with continuous stirring. Material clinging to the sides of the small beaker should be washed into the alkali solution with a mixture of 100 ml. of cold water and 100 ml. of cold methanol. The mixture is kept in an ice bath for 2 hours and stirred continuously. In the meantime, 1.5 l. of purified ethanol is cooled to 0°C.

The alkaline mixture is filtered on a large Büchner funnel. The solid is returned to the beaker by means of a porcelain spatula, washed by decantation with 350 ml. of the cold ethanol, and again filtered. This washing-by-decantation procedure is repeated four times, using 350-ml. portions of cold ethanol for each operation. The precipitate is then pressed on the funnel with the porcelain spatula and dried by pulling air through the mass. The potassium nitrocarbamate, obtained in this manner, still contains an equal weight of alcohol which cannot be removed by drying in air because decomposition occurs.

The product is transferred to a tared dish and placed in a vacuum desiccator over potassium hydroxide. The desiccator is evacuated for one hour and then placed in a refrigerator overnight. On the following day, it is evacuated again for 15 minutes and once more stored in a refrigerator. This procedure is repeated until no further loss in weight is observed, indicating complete removal of the alcohol. The desiccator must not be opened while cool, since moisture will condense on the cold inner walls and on the cold dish containing the product. Theoretical yield 60 g.; actual yields 40 to 50 g. (65 to 80 per cent of theory).

Potassium nitrocarbamate is a very unstable compound, affected by moisture, heat, and carbon dioxide. It sometimes decomposes spontaneously. It should, therefore, be prepared in no larger quantity than provided for above and stored in a vacuum desiccator over potassium hydroxide in a refrigerator.

C. NITRAMIDE

Seven and three-tenths milliliters of concentrated sulfuric acid is added to 50 ml. of water contained in a 250-ml. glass-stoppered Erlenmeyer flask. The solution is cooled in a dry ice-methanol mixture until some ice forms.

Potassium nitrocarbamate (9.1 g.) is weighed on glazed paper and, with the aid of a porcelain or platinum spatula, is added in very small portions to the cold dilute sulfuric acid. The solution is swirled continuously. Whenever the ice melts, the flask is immersed in the cold bath until ice again forms.

After addition is complete, the sides of the flask are washed with 10 ml. of water from a wash bottle. The stopper and ground portions of the flask are dried with filter paper, and 60 ml. of alcohol-free ether is added. The flask is immersed in the cold bath and swirled continuously until the water layer is entirely frozen.

The ether layer is decanted through a small fluted filter into a 125-ml. widemouthed, glass-stoppered gas-washing bottle having straight sides. The inlet tube should terminate within 2 mm. of the bottom. The last few drops of ether should not be poured off, as occasionally ice crystals will come along. If water is accidentally introduced into the ether filtrate, it must be refrozen and decanted again through another filter.

The bottle is placed in a vessel of water whose temperature is about 30°C., and a stream of dry air is drawn through the ethereal solution. In the meantime, the frozen water layer is melted completely by immersion of the containing flask in a beaker of water at 35°C. A fresh 50-ml. portion of ether is added, the aqueous layer again frozen, and the ethereal layer decanted into the same gas-washing bottle as above. This procedure is repeated twice more, making four extractions in all.

The evaporation of ether is continued in the manner outlined above until nitramide precipitates. The inlet tube is

then withdrawn and washed, both inside and outside, with a few drops of anhydrous ether, a glass tube drawn out to a capillary being used as a dropper. Sufficient wash ether should be used to dissolve all of the precipitated nitramide.

Twenty milliliters of petroleum ether is added to precipitate the nitramide. The suspension is stirred with a small porcelain or platinum spatula. The precipitate is filtered on a smooth, hardened filtered paper or fritted glass plate using slight suction. The solid is returned to the bottle by means of the spatula, washed by decantation with 10 ml. of petroleum ether, and filtered. This washing-by-decantation procedure is repeated once more. The funnel is covered with filter paper, and a *slow* stream of air is drawn through until the product is dry.* The nitramide should be in the form of pure white, shiny leaflets. If the product is slightly yellow, it should be dissolved in a minimum amount of anhydrous ethyl ether and reprecipitated with petroleum ether as above. Theoretical yield 3.1 g.; actual yields 2.3 to 2.6 g. (75 to 85 per cent of theory).

Properties

Nitramide is an extremely unstable substance although not explosive under ordinary conditions. It should be prepared only when needed and then only in small quantity. It should be stored in an open tared weighing tube in a desiccator over phosphorus pentoxide or other good drying agent. The desiccator should be kept in the refrigerator. Do not open the desiccator while the latter is cool, since moisture will condense on the cold inner walls and on the cold container. Nitramide should be handled exclusively with glass or bright platinum. Nitramide attacks brass and other base metals, producing products that accelerate its own decomposition.

* A too rapid stream of air will condense moisture as a result of cooling by rapid evaporation of the petroleum ether. This difficulty may be obviated by use of a cylindrical filtering tube guarded by a drying tube.

References

1. THIELE and LACHMAN: *Ann.*, **288**, 267 (1895).
2. MARLIES and LA MER: *J. Am. Chem. Soc.*, **57**, 2008 (1935).
3. STOUT and SCHUETTE: *Ind. Eng. Chem., Anal. Ed.*, **5**, 100 (1933).
4. ARCHIBALD: *J. Am. Chem. Soc.*, **54**, 3886 (1932).
5. PATTERSON: *Ind. Eng. Chem., Anal. Ed.*, **6**, 171 (1934).

25. SODIUM AMIDE

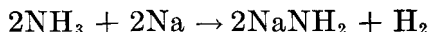

SUBMITTED BY L. M. DENNIS* AND A. W. BROWNE*

CHECKED BY W. C. FERNELIUS†

Sodium amide may be prepared readily from sodium and ammonia in either of two ways: by the reaction between liquid ammonia and sodium dissolved in it or by the reaction

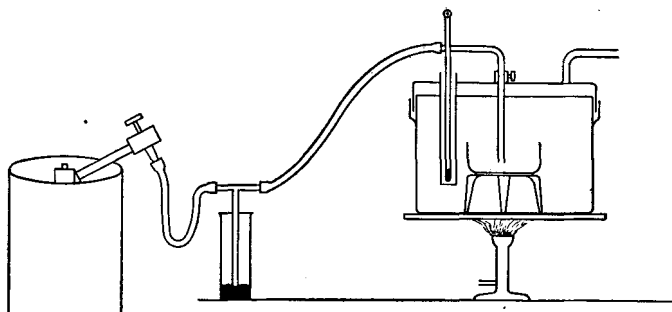

Fig. 14.—Apparatus for preparation of sodium amide.

between gaseous ammonia and molten sodium. Each method has certain advantages; but when a considerable quantity of the amide is desired, the latter is the one to be preferred.

Procedure^{1a,3}

The apparatus for the preparation of sodium amide is shown in Fig. 14. It consists essentially of an iron can or crucible‡ in which is placed a nickel dish or crucible.

* Cornell University, Ithaca, N. Y.

† The Ohio State University, Columbus, Ohio.

‡ This can may easily be made from sheet iron. Joints should be riveted,

Reaction vessels of nickel seem to be the most generally useful for the conversion of metal to amide. Vessels of glass and porcelain are rapidly attacked by the amide. Most metals are similarly attacked to a greater or lesser degree. Iron vessels are apt to introduce cyanide.^{1a,e,3} The can is so arranged that it may be heated and a stream of pure ammonia may be passed into it.

The anhydrous ammonia of commerce is a nearly pure product and needs no further purification. When it is desired that the amide be absolutely free of sodium hydroxide, the ammonia may be dried, either by passing the gas through long tubes packed with small pieces of sodium amide or barium oxide or by confining the liquid in small tanks in which have been placed a few grams of sodium.⁴ The ammonia line is provided with a side tube dipping into mercury to guard against any danger due to sudden stoppage. After heating the iron can (including the nickel dish) in a stream of ammonia to drive off the film of moisture which is present at ordinary temperatures, 100 g. of oxide-free sodium* is placed in the nickel dish, and the temperature maintained at about 350°C.†

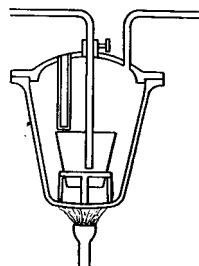

FIG. 15.—Modified apparatus for synthesis of sodium amide.

As soon as the metal melts, the inlet tube, through which the ammonia enters, is pushed beneath the surface of the sodium so that the gas may bubble up through the liquid. With this arrangement, the formation of sodium amide is much more rapid than when the ammonia gas is simply passed over the surface of the sodium.³ The flow of gas

not soldered. A modified form of the apparatus may be made readily from a quart-size iron crucible (Fig. 15) of the type stocked by the laboratory supply houses.

* Sodium that has been stored under liquid hydrocarbons should not be used, as it is apt to introduce cyanide into the final product.^{1a,3}

† In order to decrease the time of reaction, it is desirable to have the temperature as high as possible. Above 350°C., there is loss of the product by vaporization. Amide prepared below 250°C. contains sodium hydride.^{1c}

should be steady to prevent the rise of sodium in the inlet tube.

When the reaction is nearly complete (from 5 to 7 hours), the inlet tube is raised out of the liquid. The end of the reaction is shown by the absence of hydrogen in the gas escaping from the can. Hydrogen in this escaping gas may be detected by conducting the exit gas into water, collecting the insoluble gases in a test tube, and testing for inflammable gas. (**Caution!** The stream of ammonia must be sufficiently rapid to prevent the water from being drawn back into the reaction vessel.) When the conversion of sodium to amide is complete, the apparatus is allowed to cool with a stream of ammonia still passing through it. The amide is broken away from the dish and may be preserved for short periods of time in tightly stoppered bottles or for longer periods in sealed tubes. Amide prepared in this manner is found on analysis to be a pure product.^{1d} Since the only losses in preparation are by spattering and volatilization which may be very largely avoided if sufficient care is taken, the yield is practically quantitative.

Properties^{1b}

Sodium amide is a white crystalline solid (m. 210°C.) which begins to volatilize at 400°C. and decomposes into its elements between 500 and 600°C. It reacts vigorously with water and more slowly with alcohol. It must be preserved out of contact with the air not only because it is hydrolyzed by atmospheric moisture but also because it is gradually oxidized to give mixtures that detonate on heating.^{1c} Sodium amide finds many uses as a drying and dehydrating agent and as an intermediate in the synthesis of azides, sodium cyanide, and indigo. Sodium amide is also useful in many organic reactions as a condensing agent and dehalogenating agent and promises to be of value as an analytical reagent, since, in the fused condition, it completely decomposes a large variety of silicates.²

References

1. For an extensive review of the chemistry of the alkali amides, see BERGSTROM and FERNELIUS: *Chem. Rev.*, **12**, 43 (1933); (a) 52; (b) 59; (c) 63, 75, 78; (d) 65; (e) 72; cf. *ibid.*, **20**, 413 (1937).
2. PETERSON and BERGSTROM: *Ind. Eng. Chem., Anal. Ed.*, **6**, 136 (1934).
3. DENNIS and BROWNE: *J. Am. Chem. Soc.*, **26**, 587, 597 (1904).
4. FRANKLIN and KRAUS: *Am. Chem. J.*, **23**, 277 (1900); JOHNSON and FERNELIUS: *J. Chem. Education*, **6**, 443 (1929).

26. HYDROGEN AZIDE IN AQUEOUS AND ETHEREAL SOLUTIONS

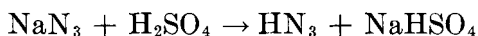

SUBMITTED BY L. F. AUDRIETH* AND C. F. GIBBS*

CHECKED BY W. C. JOHNSON† AND H. C. PERRIN‡

Aqueous solutions of hydrogen azide are readily obtained by treatment of sodium azide‡ with sulfuric acid. Since pure hydrogen azide is **extremely explosive**, and since its vapors produce most unpleasant physiological effects, it is advisable to use care in its preparation. Especially is the treatment of dry sodium azide, or of a cold solution, with sulfuric acid to be avoided, since this results in the formation of pure hydrogen azide (b. 37°C.) which may condense to the anhydrous liquid or to a highly concentrated aqueous solution, both of which are extremely explosive.

In addition to the method outlined under procedure A, hydrazoic acid may be prepared by the action of oxalic¹ or fluosilicic acids² upon solutions of sodium azide or by the treatment of barium azide solutions with dilute sulfuric acid. A method involving the action of perchloric acid upon potassium azide has also been proposed. However, subsequent distillation of the filtrate, after removal of the precipitated potassium perchlorate, is necessary to prepare pure hydrazoic acid. Pure hydrazoic acid has also been obtained by the oxidation of hydrazine in acid solution by hydrogen peroxide.³⁻⁵

* University of Illinois, Urbana, Ill.

† University of Chicago, Chicago, Ill.

‡ Sodium Azide (Technical), Eastman Kodak Company, Rochester, N. Y.

Procedure

A. HYDRAZOIC ACID (AQUEOUS SOLUTION OF HYDROGEN AZIDE)

Fifteen grams of sodium azide and 5 g. of sodium hydroxide* are dissolved in 150 ml. of water contained in a 250-ml. distilling flask fitted with a dropping funnel and attached to an efficient condenser. The end of the condenser is connected by means of an adapter to a 500-ml. filter flask containing 100 ml. of water. A tube leading to a hood outlet is connected to the side arm of the filter flask. The solution in the distilling flask is brought to the boiling point (**very important!**), and 90 ml. of 40 per cent sulfuric acid is then added drop by drop. The distillation is continued until only about 50 ml. of solution remains in the distilling flask. Hydrazoic acid containing about 3 per cent of hydrogen azide (0.6 to 0.7N) may be obtained in this way.

B. ANHYDROUS ETHEREAL SOLUTION OF HYDROGEN AZIDE

Since the distribution ratio of hydrogen azide between the two solvents ether and water is approximately 7:1, ethereal solutions may be prepared by extraction of aqueous solutions with ether. However, the procedure used by Frost, Cothran, and Browne⁶ is preferable.

Thirty grams of sodium azide, dissolved in 100 ml. of water and 150 ml. of ether, is placed in a 500-ml. round-bottom flask. The latter is connected through a Hopkins (or Reitmeier) bulb with a suitable condenser and a receiving vessel. The receiver contains 100 ml. of ether and is immersed in an ice bath. The generator is also fitted with a dropping funnel which dips below the surface of the solution and through which 30 ml. of concentrated sulfuric acid is slowly introduced. Most of the hydrogen azide and ether distill into the receiver during the addition

* The addition of sodium hydroxide is purely precautionary. It avoids the formation of a high concentration of hydrogen azide in a cold solution.

of the acid. The remainder may be recovered by heating the flask on a steam bath for a short time. The ethereal distillate is dried over calcium chloride and then redistilled from the desiccant.

References

1. EINIG: German patent 435,654; *Chem. Zentr.*, 1926, II, 3072.
2. HOTH and PYL: *Z. angew. Chem.*, **42**, 888 (1929).
3. BROWNE: *J. Am. Chem. Soc.*, **27**, 551 (1905).
4. MARTIN: *J. Am. Chem. Soc.*, **49**, 2133 (1927).
5. AUDRIETH: *Chem. Rev.*, **15**, 169 (1934).
6. FROST, COTHRAN, and BROWNE: *J. Am. Chem. Soc.*, **55**, 3516 (1933).

27. POTASSIUM AZIDE*

(Alkali and Alkaline Earth Azides)

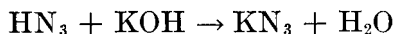

SUBMITTED BY A. W. BROWNE†

CHECKED BY L. F. AUDRIETH† AND E. LANNERUD‡

Potassium, rubidium, and cesium azides are of particular interest, since they undergo thermal decomposition at higher temperatures with the formation of the free alkali metals and the evolution of nitrogen in accordance with the equation



These azides may therefore be employed for the preparation of small quantities of very pure potassium, rubidium, or cesium.¹ They have also been decomposed to obtain very pure nitrogen.²

Only the preparation of potassium azide is described here. However, the method outlined below can be adapted to the preparation of the alkali and alkaline earth azides in general. It is also suggested for the purification of technical sodium azide. The usual methods for the synthesis of sodium azide by the nitrous oxide-sodium amide³ method or the hydrazine-alkyl nitrite⁴ procedure have either not

* Azides are also called trinitrides, azoimides, and triazoates.

† Cornell University, Ithaca, N. Y.

‡ University of Illinois, Urbana, Ill.

yet been or are not easily adapted to the direct preparation of the other azides. Consequently, technical sodium azide⁵ must serve as the starting material for their preparation.

Procedure

A 3 per cent solution of hydrazoic acid (synthesis 26A) is neutralized with an aqueous solution of pure potassium hydroxide. The resulting solution of potassium azide is concentrated on the steam bath to incipient crystallization. The solution is then made slightly acid with hydrazoic acid to replace the hydrogen azide lost by hydrolysis. A volume of ethyl alcohol twice that of the solution is added, and the solution is cooled in an ice bath. Since the solubility in alcohol of the alkali and alkaline earth azides is very slight (see table below), precipitation in the form of a white microcrystalline salt takes place readily. From 90 to 95 per cent recovery of the theoretical quantity of potassium azide can be effected. The precipitated azide is filtered on a Büchner funnel and washed with cold absolute alcohol and then with ether. Any traces of adhering solvent may be removed in a vacuum desiccator. In a typical run, 300 ml. of a solution of hydrazoic acid containing 8.5 g. of HN_3 was neutralized with potassium hydroxide, and the isolation of potassium azide effected as indicated above. Yield 14.7 g. (91.5 per cent) KN_3 .

Properties⁶

The melting points of those azides which melt without decomposition are given in the first column of the table below. The decomposition temperatures noted in the second column are those determined by Tiede⁷ and by Suhrmann and Clusius¹ and refer to the temperatures at which decomposition of the azides into metal and nitrogen takes place. Once such decomposition has begun, it may be continued at a lower temperature, as indicated by the figures given in the third column. The solubilities of the azides in water and in ethyl alcohol are also summarized.

PROPERTIES OF THE ALKALI AND ALKALINE-EARTH AZIDES⁶

Formula	M., °C.	Initial decomposition temp., °C.	Decomposition temp., °C.	Solubility in 100 g. H ₂ O, g.	Solubility in 100 g. C ₂ H ₅ OH, g.
LiN ₃	66.41 16°	20.26 16°
NaN ₃	300	280	41.7 17°	0.22 0°
KN ₃	350	355	360	49.6 17°	0.14 16°
RbN ₃	330	395	310	114.1 17°	
CsN ₃	326	390	350	307.4 16°	1.04 16°
Ca(N ₃) ₂	110	100	45. 15.2°	0.211
Sr(N ₃) ₂	140	110	45.83 16°	sl. sol.
Ba(N ₃) ₂	160	120	16.7 15°	sl. sol.

References

1. SUHRMANN and CLUSIUS: *Z. anorg. allgem. Chem.*, **152**, 52 (1926).
2. JUSTI: *Ann. Physik*, [5] **10**, 983 (1931).
3. DENNIS and BROWNE: *J. Am. Chem. Soc.*, **26**, 577 (1904).
4. THIELE: *Ber.*, **41**, 2681 (1908); STOLLÉ: *Ber.*, **41**, 2811 (1908); WILCOXON and GROTTA: U. S. patent 1,628,380.
5. Eastman Kodak Company, Rochester, N. Y.
6. For a comprehensive discussion of hydrazoic acid and its inorganic derivatives, see AUDRIETH: *Chem. Rev.*, **15**, 169 (1934).
7. TIEDE: *Ber.*, **49**, 1742 (1916).
8. This is from a more complete table given by AUDRIETH (see ref. 6, p. 203).

28. AZIDODITHIOCARBONIC ACID (AZIDOTHIOFORMIC ACID) AND AZIDOCARBONDISULFIDE

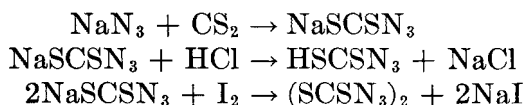

SUBMITTED BY G. B. L. SMITH*
CHECKED BY FRANK WILCOXON†

A few salts of azidodithiocarbonic acid were first prepared by Sommer¹ by the reaction of azides (trinitrides) with carbon disulfide:

* Polytechnic Institute of Brooklyn, Brooklyn, N. Y.

† Boyce Thompson Institute, Yonkers, N. Y.

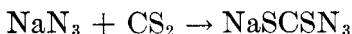

These studies have been extended by A. W. Browne and his coworkers,²⁻⁶ so that our knowledge of the chemistry of azidodithiocarbonic acid and the halogenoid azidocarbon disulphide is more complete than for most halogenoid compounds. The *highly explosive* character of the free halogenoid and of most of the anhydrous salts, particularly those of the *heavy metals*, makes them *very dangerous* and extremely difficult to handle.

A. PREPARATION OF AZIDODITHIOCARBONIC ACID, HSCSN_3 ⁵

Recrystallized sodium azide (12 g.) is dissolved in 50 ml. of water, and 12 ml. of carbon disulfide is added. The mixture is placed in a small flask fitted with a reflux condenser and kept at a temperature of about 40°C. for approximately 48 hours. If carbon disulfide is lost by volatilization, more is added from time to time. The resulting solution of sodium azidodithiocarbonate is filtered, chilled in an ice bath, and treated with chilled concentrated hydrochloric acid. The white, crystalline precipitate is washed twice by decantation with ice water, separated by filtration on a Büchner funnel, dried on a porous plate or between filter paper, preserved in a desiccator protected from the light, and kept at a temperature below 10°C. (In this way, azidodithiocarbonic acid may be kept for 24 to 48 hours without appreciable decomposition.)

B. PREPARATION OF AZIDOCARBONDISULFIDE, $(\text{SCSN}_3)_2$ ⁴

Approximately 5 ml. of the filtered solution of sodium azidodithiocarbonate obtained as described in the preceding paragraph is diluted to 200 to 300 ml. with water. A normal solution of iodine dissolved in potassium iodide is added drop by drop, with continual stirring, until complete precipitation of azidocarbon disulfide has been effected. The slightest excess of iodine must be avoided, however, as iodine is adsorbed by the azidocarbon disulfide and can be

removed only with considerable difficulty by washing. If an excess of iodine is inadvertently added, this may be reduced by adding a small amount of a dilute solution of sodium azidodithiocarbonate. The precipitated azidocarbon disulfide is separated by filtration on a Büchner funnel, washed with cold water several times, and partially dried by suction. Small portions are carefully spread upon a porous plate with the aid of a bone spatula, *tapping or undue pressure being avoided*, and are finally stored in a desiccator over phosphorus pentoxide, kept at 10° or lower, to minimize spontaneous decomposition.

(Caution. *Azidocarbon disulfide will detonate with great violence when heated to temperatures above 40° or when subjected to mechanical impact. Explosions have frequently occurred at various stages of its preparation and investigation. It undergoes spontaneous decomposition, and this reaction is autocatalytic so that the partially decomposed material is exceedingly sensitive. Azidocarbon disulfide should not be kept longer than 48 hours at 10°C. Anyone working with the material or the explosive salts should exercise great care in order to avoid serious injury. When handling the dry materials, gloves and goggles should be worn, and manipulations should be carried out behind heavy wooden screens. The worker should at all times be in such a position that if the material detonated he would not be injured. Quantities greater than 1 g. should never be handled. The free acid will detonate, but the explosion is not so violent as that of azidocarbon disulfide unless confined. The explosion is more like that of black gunpowder or nitrosoguanidine.)*

Azidodithiocarbonic acid, azidocarbon disulfide, and the azidodithiocarbonates are useful substances in illustrating the properties of halogenoids. Rather spectacular lecture demonstrations may be made by using these compounds, but they should not be attempted except by an experienced chemist. Some of the heavy metal azidodithiocarbonates are powerful detonators but have proved too sensitive for practical application.

References

1. SOMMER: *Ber.*, **48**, 1833 (1915).
2. WALDEN and AUDRIETH: *Chem. Rev.*, **5**, 339 (1928).
3. BROWNE and HOEL: *J. Am. Chem. Soc.*, **44**, 2106 (1922).
4. BROWNE, HOEL, SMITH, and SWEZEY: *J. Am. Chem. Soc.*, **45**, 2541 (1923).
5. SMITH, WILCOXON, and BROWNE: *J. Am. Chem. Soc.*, **45**, 2604 (1923).
6. SMITH, GROSS, BRANDES, and BROWNE: *J. Am. Chem. Soc.*, **56**, 1116 (1934).

29. THIOCYANOGEN SOLUTION

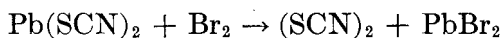

SUBMITTED BY WILLIAM HOWLETT GARDNER* AND HAROLD WEINBERGER*
CHECKED BY D. T. ENGLIS† AND E. C. PRICE†

All methods that have been suggested for the preparation of thiocyanogen solutions involve the use of strictly anhydrous solvents, since the presence of moisture causes rapid hydrolysis and decomposition to take place. It is possible, however, to stabilize thiocyanogen in aqueous solution to a limited extent by the presence of large quantities of potassium thiocyanate.

Thiocyanogen has been prepared by the action of iodine upon an ethereal suspension of silver thiocyanate.¹ This reaction does not go to completion, since thiocyanogen is a halogenoid² lying between bromine and iodine in order of chemical activity. It can be prepared by the oxidation of a solution of hydrogen thiocyanate in ether with manganese dioxide.³ The electrolysis of thiocyanates in alcoholic solution results in the discharge of the thiocyanate radical and the formation of thiocyanogen as an anodic product.⁴ The interaction of plumbic acetate and thiocyanic acid in ethereal solution presumably results in the formation of plumbic thiocyanate which immediately decomposes into thiocyanogen and plumbous thiocyanate.³

The action of bromine upon various metallic thiocyanates gives thiocyanogen in better yield, but few solvents yield

* Polytechnic Institute of Brooklyn, Brooklyn, N. Y.

† University of Illinois, Urbana, Ill.

solutions that are stable for any length of time at room temperatures and that can be used as standard solutions for thiocyanometric analyses. Acetic acid, free from organic material and containing an excess of acetic anhydride, has been found to give the best results. The procedure recommended involves the action of bromine upon a suspension of plumbous thiocyanate in a mixture of acetic acid and acetic anhydride.⁵

Procedure

Plumbous thiocyanate is prepared by the interaction of sodium thiocyanate and lead nitrate in aqueous solution. It is recommended that both of these reagents be recrystallized to remove impurities. Two solutions are prepared, one containing 25 g. of purified sodium thiocyanate; the other, 45 g. of the purified lead nitrate, each in 100 ml. of distilled water. Both solutions are cooled to 0 to 5°C., and the solution of the sodium salt added to that containing the lead nitrate. The precipitated plumbous thiocyanate is filtered, washed with ice water, and allowed to dry over a suitable desiccant in the dark.

Acetic Acid-Acetic Anhydride Solution. One kilogram of glacial acetic acid is dehydrated in a 3-l. flask over phosphorus pentoxide. The supernatant liquid is then fractionally distilled in an all-glass apparatus,* and the portion boiling between 118 to 118.5° is collected. This procedure is repeated until the product has a melting point of 15.6°C. corresponding to that of 99.5 per cent acetic acid.† To the pure acetic acid 10 per cent acetic anhydride is now added. This solution should be kept in a stoppered container protected from moisture.

* If an all-glass apparatus is not available, it is advisable to protect all cork connections with silver foil.

† A sample of this product should show no reaction with 0.1N potassium permanganate after standing 24 hours at room temperature.

If synthetic glacial acetic acid (99.5 per cent) is available and has the proper melting point, the procedure in this paragraph may be omitted, except for the addition of acetic anhydride.

Bromine Solution. Eight and four-tenths grams of pure bromine is dissolved in 200 ml. of redistilled, water-free carbon tetrachloride. To this is added 300 ml. of the specially prepared acetic acid solution.

Preparation of Thiocyanogen Solutions. To a suspension of 30 g. of plumbous thiocyanate in 300 ml. of the acetic acid is added 5 ml. of the bromine solution. The mixture is agitated vigorously on a shaking machine until it is practically colorless, and another portion of the bromine solution is added. This procedure is continued until all the bromine solution has been added. The mixture is then rapidly filtered through a dry fluted filter paper. ‡

Properties

The thiocyanogen solution is standardized by treating with an excess of potassium iodide and titrating the liberated iodine with standard sodium thiosulfate. The burette containing the halogenoid solution is protected against moisture by a tube containing calcium chloride or phosphorus pentoxide.

This method gives an approximately 0.1N solution and retains its strength for about 8 days. It has been utilized for the purpose of evaluating the amount of unsaturation in various fats and oils.⁶ The solution has also been used to determine thiocyanogen numbers for resins.⁷

References

1. SÖDERBÄCK: *Ann.*, **419**, 217 (1919).
2. WALDEN and AUDRIETH: *Chem. Rev.*, **5**, 339 (1928).
3. KAUFMANN and KÖGLER: *Ber.*, **58B**, 1553 (1925).
4. KERSTEIN and HOFFMANN: *Ber.*, **57B**, 491 (1924).
5. KAUFMANN: *Chem. Ztg.*, **49**, 768 (1925); *Arch. Pharm.*, **263**, 675 (1925).
6. MITCHELL: "Recent Advances in Analytical Chemistry," Vol. 1, p. 78, P. Blakiston's Son & Company, Inc., Philadelphia, 1930.
7. GARDNER, PRIBYL, and WEINBERGER: *Ind. Eng. Chem., Anal. Ed.*, **6**, 259 (1934).

‡ If traces of moisture are present, a pink color is imparted to the filter paper. This is to be avoided in all cases.

30. HYDROXYLAMINE

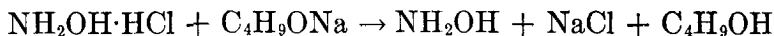

SUBMITTED BY CHARLES D. HURD*

CHECKED BY L. F. AUDRIETH† AND L. A. NALEFSKI†

Two general methods may be employed in the preparation of hydroxylamine involving either the thermal dissociation of certain hydroxylamine compounds or the interaction of hydroxylamine hydrochloride suspended in an alcohol with the corresponding sodium alcoholate. The first of these methods was used both by Crismer,¹ who distilled zinc chloride dihydroxylamate under reduced pressure; and by Uhlenhut,² who decomposed tertiary hydroxylamine phosphate. These procedures are extremely wasteful, owing to the instability of hydroxylamine at the temperatures required to bring about dissociation. Any hydroxylamine that is not isolated is totally lost.

The solubility of hydroxylamine decreases with increasing molecular weight of the alcohols employed as solvents for the reaction between the hydrochloride and the alcoholate. Brühl³ used methyl alcohol, whereas Lecher and Hofmann⁴ increased the yield by crystallization from ethyl alcohol. Subsequent investigation showed that butyl alcohol⁵ gives still better results. The procedure outlined below using butyl alcohol is far superior to the older vacuum-distillation method.⁶

Procedure

A 1-l. round-bottom flask is fitted with a rubber stopper carrying a mechanical stirrer. A tight-fitting stirrer is desirable, although it is unnecessary to employ a mercury seal. The stopper also carries a glass tube with a capillary outlet to the atmosphere (to serve as a pressure vent) and a tube for the delivery of the butoxide solution from a dropping funnel. This delivery tube should be bent

* Northwestern University, Evanston, Ill.

† University of Illinois, Urbana, Ill.

so that the solution may be introduced into that part of the flask which is stirred most effectively. The lower part of the dropping funnel above the stopcock is equipped with a steam coil* to prevent solidification of the sodium butoxide.

A sodium butoxide solution is prepared in a flask attached to a reflux condenser by heating 23.5 g. of sodium with 300 ml. of commercial redistilled butyl alcohol (b. 115.5 to 117.5°C.). The resulting solution must be sufficiently free from color so as not to mask the effect of the indicator.† The sodium dissolves rather slowly unless an elevated temperature is maintained. The brown color which is imparted to the warm alkaline solution as it is poured rapidly from the flask to the dropping funnel is not troublesome.

Seventy grams (1.0 mol) of dry finely powdered hydroxylamine hydrochloride and 0.01 to 0.02 g. of solid phenolphthalein are placed in the flask. One hundred milliliters of butyl alcohol is added; and after 10 minutes of preliminary stirring, the butoxide solution is introduced at such a rate that the pink color of the indicator never predominates. After about 2.5 hours, the end point of the reaction is just exceeded. To discharge the pink color, a small quantity of hydroxylamine hydrochloride is introduced in the flask, and stirring is continued until the solution becomes colorless.

The sodium chloride is collected upon a filter and is pressed as dry as possible. It is washed with several milliliters of butyl alcohol and then with four 15-ml. portions of absolute ether. The addition of the ether serves further to reduce the solubility of the hydroxylamine in the filtrate, which is placed in a tightly stoppered flask and cooled to -10°C .

* Such a coil can be made by winding $\frac{3}{16}$ -in. lead tubing around the dropping funnel.

† The brown color is due to oxidation by air. Air may be kept from entering the condenser by allowing the hydrogen gas which is generated during the reaction to escape through a small exit tube which is shaped into an inverted U. This hydrogen trap is connected to a soda-lime tube to exclude moisture and carbon dioxide.

Hydroxylamine begins to crystallize in large white flakes at 0°C. Cooling below -10°C. seems to produce only a trivial increase in the yield. The crystals produced in this fashion are collected quickly upon a filter (Witt plate), washed with cold ether, and placed in a desiccator for 15 minutes to remove the adhering solvents. If the hydroxylamine is not to be used at once, it should be placed in a stoppered tube in an ice chest. Yield 21.0 g. (63.5 per cent of theory).

The remaining 12 g. of hydroxylamine is in the filtrate and may be recovered as hydroxylamine hydrochloride. For this purpose, concentrated hydrochloric acid is added until no further precipitate forms. The precipitate is removed by filtration and dried. Yield 15 g. The filtrate consists chiefly of butyl alcohol but contains in addition the excess acid, water, and some unprecipitated hydroxylamine hydrochloride. Treatment with dry potassium carbonate and distillation are the only steps necessary to recover most of the butyl alcohol.

Properties

Hydroxylamine is an exceedingly unstable compound melting, when absolutely pure, at 33° and boiling at 58° at a pressure of 22 mm.⁶ It is apt to explode violently at higher temperatures. It undergoes rapid decomposition at room temperatures, especially in the presence of moisture and the carbon dioxide of the air. It is very soluble in water, liquid ammonia, and methyl alcohol. Its solubility in the higher alcohols decreases with increasing molecular weight of the latter.

References

1. CRISMER: *Bull. soc. chim.*, [3] **3**, 115 (1890); **6**, 793 (1891).
2. UHLENHUT: *Ann.*, **311**, 117 (1900).
3. BRÜHL: *Ber.*, **26**, 2508 (1893); **27**, 1347 (1894).
4. LECHER and HOFMANN: *Ber.*, **55B**, 912 (1922).
5. HURD and BROWNSTEIN: *J. Am. Chem. Soc.*, **47**, 67 (1925).
6. DE BRUYN: *Rec. trav. chim.*, **11**, 18 (1892).

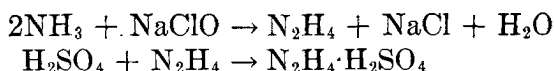
31. HYDRAZINE SULFATE

SUBMITTED BY L. F. AUDRIETH* AND T. T. NICKLES*

CHECKED BY G. GIBSON† AND R. E. KIRK‡

The only satisfactory method for synthesizing hydrazine was devised by Raschig¹ and involves the oxidation of ammonia by sodium hypochlorite in the presence of some such catalyst as glue or gelatin. The purpose of the catalyst is to raise the viscosity of the solution and to inhibit the effect, by adsorption, of traces of metallic ions which cause decomposition of the hydrazine formed.² It is therefore advisable to use distilled water. Since free chlorine, if present in the hypochlorite solution, oxidizes ammonia to nitrogen, special care must be taken in the preparation of the oxidizing solution. The hypochlorite solution should be distinctly alkaline.‡

Procedure

For the preparation of the hypochlorite solution, 320 g. (8 mols) of sodium hydroxide is dissolved in 1500 ml. of distilled water, and 1500 g. of cracked ice is added. The container is placed in an ice-salt bath, and chlorine is introduced slowly until the solution has absorbed 210 to 245 g. (corresponding to 6 to 7 g.-atoms of chlorine). Ice must be present in the solution at all times to insure a temperature of 0°C. If the temperature rises much above 0°C., some of the hypochlorite will undergo autooxidation

* University of Illinois, Urbana, Ill.

† Polytechnic Institute of Brooklyn, Brooklyn, N. Y.

‡ The importance of this factor upon the yield of hydrazine has apparently been overlooked, although directions usually call for hypochlorite solutions that are alkaline. Maximum yields are obtainable when the amount of unreacted sodium hydroxide per atom of chlorine introduced amounts to 0.1 to 0.15 mol. It has been shown by the authors that with decreasing quantities of free sodium hydroxide smaller yields of hydrazine are obtained.

to the chlorate. If the solution is not to be used immediately, it is advisable to store it in an ice chest.

In a 16-in. evaporating dish are placed 1 l. of 28 per cent ammonia (sp. gr. 0.90), 600 ml. of distilled water, and 250 ml. of a 10 per cent gelatin solution. To this solution 800 ml. of the hypochlorite, prepared as indicated above, is added. There should be no appreciable gas evolution upon the addition of the hypochlorite.* The whole solution is then heated as rapidly as possible to the boiling point, evaporated to one-third of its original volume, cooled, filtered through a Büchner funnel, and the container placed in an ice-salt mixture. A mechanical stirrer is introduced, and 200 to 250 ml. of 40 per cent sulfuric acid (sp. gr. 1.3)† added slowly from a dropping funnel, care being taken to keep the temperature in the neighborhood of 0°C. After all of the acid has been added, the solution is allowed to stand for an hour at 0°C. The hydrazine sulfate is filtered on a suction funnel, washed with 25 ml. of ice water, and then washed with cold alcohol. A fairly pure product melting at 254°C. is obtained. Calculated on the basis of 800 ml. of a hypochlorite solution containing 60 g. of NaClO, a yield of 37 g. or 35 per cent of the theoretical is obtainable. The hydrazine sulfate remaining in solution and in the wash water may be recovered as indicated in synthesis 32.

References

1. RASCHIG: *Chem. Ztg.*, **31**, 926 (1907); see also JOYNER: *J. Chem. Soc.*, **123**, 1114 (1923).
2. BODENSTEIN: *Z. physik. Chem.*, **139A**, 397 (1928).

* If gas evolution takes place, it indicates either that the hypochlorite solution contains free chlorine or has undergone autooxidation or that the viscolizer employed is not satisfactory or not concentrated enough. For the experimental work outlined above, the authors found Difco brand gelatin (Difco Laboratories, Detroit, Mich.) very satisfactory.

† Some authors prefer to use concentrated sulfuric acid. However, a discolored product is often obtained due to carbonization of the gelatin. Furthermore, it is necessary to watch the temperature continually when concentrated acid is added. Using 40% sulfuric acid, the rate of addition

32. RECOVERY OF HYDRAZINE RESIDUES AS HYDRAZINE DIHYDROCHLORIDE OR HYDRAZINE SULFATE

1. $\text{N}_2\text{H}_4 + 2\text{C}_6\text{H}_5\text{CHO} \rightarrow \text{C}_6\text{H}_5\text{CH}=\text{N}-\text{N}=\text{CHC}_6\text{H}_5 + 2\text{H}_2\text{O}$
2. $(\text{C}_6\text{H}_5\text{CHN}-)_2 + 2\text{H}_2\text{O} + 2\text{HCl} \rightarrow 2\text{C}_6\text{H}_5\text{CHO} + \text{N}_2\text{H}_4 \cdot 2\text{HCl}$
3. $(\text{C}_6\text{H}_5\text{CHN}-)_2 + 2\text{H}_2\text{O} + \text{H}_2\text{SO}_4 \rightarrow 2\text{C}_6\text{H}_5\text{CHO} + \text{N}_2\text{H}_4 \cdot \text{H}_2\text{SO}_4$

SUBMITTED BY L. F. AUDRIETH* AND T. T. NICKLES*
CHECKED BY G. GIBSON† AND R. E. KIRK†

Although it has long been known that benzaldehyde reacts with hydrazine in alkaline solution to give a yellow, insoluble precipitate of benzalazine¹ and that the latter when steam distilled in the presence of mineral acids is hydrolyzed to give the corresponding hydrazine salts,² no previous attempt has been made to apply these facts to the recovery of hydrazine residues. This reaction is practically quantitative and can be applied not only to the recovery of residual hydrazine left in solution in the Raschig synthesis (No. 31) but to all solutions where the detection and recovery of hydrazine in the presence of ammonia, or hydroxylamine, are of interest. In the process of formation of hydrazine salts from benzalazine, 95 per cent of the benzaldehyde can be recovered.

This method is obviously superior to the one involving precipitation of the hydrazine sulfate as the slightly soluble copper double salt. The latter must be decomposed with hydrogen sulfide for removal of the copper, and the solution evaporated to the point of crystallization.

In carrying out the recommended procedure, care must be taken to avoid an excess of benzaldehyde, as benzalazine

can easily be regulated and, for the quantities specified above, completed in 20 minutes.

* University of Illinois, Urbana, Ill.

† Polytechnic Institute of Brooklyn, Brooklyn, N. Y.

is somewhat soluble in the latter. The first part of the procedure indicates that this method is a highly efficient one. It must, of course, be modified to fit individual requirements.

Procedure

Conversion of Hydrazine Sulfate into Benzalazine. Residues containing 25 g. of hydrazine sulfate are dissolved in 5 l. of water, and the solution made distinctly alkaline to methyl orange with sodium hydroxide. Forty-one grams of benzaldehyde is added, and the solution shaken thoroughly. The milky suspension that forms is allowed to stand (overnight) until the yellow precipitate has settled out and the supernatant liquid has become clear. The precipitate is filtered, washed thoroughly with water, and dried at room temperature. Yield 39 g. (98 per cent) of benzalazine; melting point 93°C. after recrystallization from alcohol.

Preparation of Hydrazine Dihydrochloride from Benzalazine. One hundred and four grams of benzalazine (0.5 mol) is suspended in 400 ml. of water in a 4-l. round-bottom flask, and 80 ml. of concentrated hydrochloric acid added. The suspension is subjected to steam distillation* until no more benzaldehyde† comes over in the distillate.

Since the solution is usually discolored, it is advisable to treat it at this point with adsorbent charcoal (Norit). After heating the solution for 15 minutes, the decolorizing agent is removed by filtration, and the solution concentrated on the steam bath to a volume of 60 ml. The concentrate is cooled to room temperatures, and 10 ml. of concentrated hydrochloric acid added. Further cooling in an ice-salt mixture results in the crystallization of the dihydrochloride. The addition of ethanol to the mother liquor causes more complete precipitation. The crystalline

* The flask should be heated on the steam bath during the distillation.

† The separation of benzaldehyde from this distillate is aided materially by the addition of a "salting out" agent, such as sodium sulfate.

salt is filtered and washed with alcohol and finally with ether. Yield 49 g. (93 per cent); melting point 199°C.

Preparation of Hydrazine Sulfate from Benzalazine. One hundred and four grams of crude benzalazine (obtainable from the residual solutions of the Raschig synthesis) is suspended in 400 ml. of water, and 60 ml. of concentrated sulfuric acid added. The solution is steam distilled until no more benzaldehyde comes over and then cooled in an ice-salt mixture to bring about precipitation of the sulfate. Yield 60 g. of $N_2H_4 \cdot H_2SO_4$ (92 per cent).

References

1. CURTIUS and JAY: *J. prakt. Chem.*, [2] **39**, 44 (1889).
2. SCHESTAKOFF: *J. Russ. phys. Chem. Soc.*, **37**, 1 (1905); *J. Chem. Soc. Abstr.*, **88**, i, 332 (1905).

33. GUANIDINE NITRATE

Practically all methods which have been proposed for the preparation of guanidine salts involve either ammoniation or ammonolysis of some derivative of carbonic acid. Phosgene,¹ chloropicrin,² and esters of orthocarbonic acid² react with aqueous ammonia to give small yields of guanidine. The hydrochloride is obtained when carbon tetrachloride³ is acted upon by liquid ammonia under pressure. Urea⁴ is partially ammonolyzed in the presence of ammonium chloride.

Fusion of ammonium thiocyanate,^{5,6} either alone or in the presence of heavy metal salts, at 180°C., gives guanidine thiocyanate. This procedure has been modified by heating lead nitrate with a solution of ammonium thiocyanate in liquid ammonia at 120°.⁷ Lead sulfide is formed, and guanidine nitrate recovered. Other methods of formation involve the hydrolysis of dicyandiamide⁸⁻¹⁰ and the nitridation¹¹ of methyl amine by means of ammonium azide in liquid ammonia.

Although methods involving the fusion of ammonium thiocyanate* were for a long time the only ones employed

* Although guanidine thiocyanate is readily prepared by this method, it is extremely deliquescent and cannot be obtained in so pure a state as guanidine nitrate.

industrially to any extent, they are now being supplanted by other methods, all of which make either direct or indirect use of calcium cyanamide as the starting material.

Dicyandiamide, which is readily obtainable from calcium cyanamide and is a stable commercial product, may be converted into guanidine nitrate by the action of ammonium nitrate, either in concentrated aqueous solution under pressure^{12,13} or by a fusion reaction.¹³⁻¹⁶ The latter procedure gives a very pure product and is to be preferred for laboratory practice. Directions for its use are given under procedure A.

Cyanamide is also acted upon directly by ammonium salts in aqueous and non-aqueous solutions.¹⁷⁻²⁰ Since it is of decided advantage to avoid the isolation of pure cyanamide, methods have been developed in which aqueous solutions of cyanamide are prepared from calcium cyanamide and are then permitted to react with ammonium salts. However, guanidine nitrate may also be prepared directly from commercial calcium cyanamide by the action of ammonium nitrate. This reaction takes place readily in the fused state, in concentrated aqueous solution,²¹ or by direct admixture of solid ammonium nitrate with calcium cyanamide and subsequent heating to 100°C.²² The latter procedure is to be preferred, since better yields are obtainable and the hazard of fusion with ammonium nitrate is obviated. The directions given for procedure B require the use of a fairly good grade of *unoiled* calcium cyanamide containing approximately 65 per cent CaNCN.

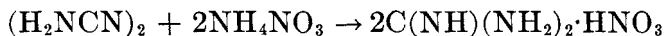
A. GUANIDINE NITRATE BY FUSION OF AMMONIUM NITRATE WITH DICYANDIAMIDE¹⁶

SUBMITTED BY G. B. L. SMITH*

CHECKED BY L. F. AUDRIETH†

The fusion reaction described below appears to take place in two stages with the intermediate formation of biguanide nitrate.^{16,15,13} The formation of biguanide is endothermic; its conversion into guanidine, exothermic. Accordingly, the temperature may be controlled by adding the second half of the dicyandiamide slowly so that the exothermic and endothermic reactions take place simultaneously. It is essential to hold the temperature as near 160 to 165°C. as possible, since higher temperatures favor reactions that yield impurities such as ammalide, ammelide, and melamine, whereas lower temperatures do not effect complete conversion into guanidine. The following procedure gives guanidine nitrate of high purity.

Procedure

Two hundred and sixty-four grams (3.3 mols) of thoroughly dried ammonium nitrate, preheated to 110°C., is mixed with 63 g. (0.75 mol) of dicyandiamide, which has also been heated to 110°C. This mixture is placed in a 600-ml. beaker and rapidly brought to a temperature of 162 to 165°C. An additional 63 g. of dicyandiamide is added within ½ hour at such a rate as to prevent spontaneous superheating above 165°C. The material is kept at a temperature of 162 to 165°C. for a total period of 1 hour. During the cooling, the melt is stirred to prevent caking. While still warm, it is dissolved in 900 ml. of water at 80°C., filtered, and 5 ml. of concentrated nitric acid is added. The solution is cooled rapidly to room temperature, and the guanidine nitrate separated by

* Polytechnic Institute of Brooklyn, Brooklyn, N. Y.

† University of Illinois, Urbana, Ill.

filtration. Second and third crops of crystals are recovered by further evaporation of the mother liquor. This slightly impure guanidine nitrate is dissolved in 3 l. of hot methanol, the insoluble material removed by filtration, and the solution concentrated to approximately 1 l. by distillation. On cooling to room temperature, guanidine nitrate separates. The pure compound melts at 217°C. Yield 300 to 315 g. (80 to 87 per cent of theory).

**B. GUANIDINE NITRATE FROM CALCIUM CYANAMIDE
AND AMMONIUM NITRATE**

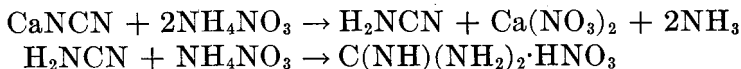

SUBMITTED BY MARVIN T. SCHMIDT* AND L. F. AUDRIETH*
CHECKED BY L. P. FULLER† AND G. B. L. SMITH†

According to Gockel,²² this reaction takes place in the following manner: Dry ammonium nitrate reacts with calcium hydroxide present in the crude calcium cyanamide to give calcium nitrate, water, and ammonia. The ammonia and water do not escape but are absorbed by the calcium nitrate to give a mixture of hydrated and ammonated salt and also by the ammonium nitrate which is ammono-deliquescent (Diver's solution). These substances melt below 100°C. and provide a solvent in which the reaction between calcium cyanamide and ammonium nitrate may take place.

Procedure

Six hundred grams of crude calcium cyanamide is mixed with 1500 g. of ammonium nitrate in a 4-l. flask and heated on a steam bath. After about 6 hours of heating, the mixture becomes thick and pasty and eventually assumes the consistency of a viscous fluid. When the mass has reached the latter stage, samples are withdrawn every half hour, diluted and filtered, and tested for cyanamide with a

* University of Illinois, Urbana, Ill.

† Polytechnic Institute of Brooklyn, Brooklyn, N. Y.

10 per cent ammoniacal silver nitrate solution. When the yellow precipitate of silver cyanamide is no longer obtained, indicative of the fact that the reaction is complete, the flask is removed from the steam bath, and 2500 ml. of hot water is added to the mixture. A large amount of ammonia is evolved.

The solution is filtered, and the residue is washed with a 500-ml. portion of hot water. The combined filtrates are allowed to cool, and the crystals removed by filtration. The mother liquor is evaporated to half its volume and again allowed to cool. After the second crop of crystals is removed, the mother liquor usually no longer gives a test for guanidine when ammonium picrate is added to a test sample.

The total yield of crude product contaminated with considerable ammonium nitrate is 750 to 800 g. The crude product is dissolved in 1500 ml. of hot water, and the solution is filtered and allowed to cool. The yield of guanidine nitrate by careful recrystallization amounts to 450 g., or 75 per cent. The resulting product is satisfactory for most purposes; but if still higher purity is required, it may be recrystallized from methanol as described in procedure A.

References

1. BOURCHARDT: *Compt. rend.*, **69**, 961 (1869).
2. HOFMANN: *Ann.*, **139**, 107 (1866).
3. STÄHLER: *Ber.*, **47**, 909 (1914).
4. BLAIR: *J. Am. Chem. Soc.*, **48**, 87 (1926).
5. VOLHARDT: *J. prakt. Chem.*, [2] **9**, 15 (1874).
6. DELITSCH: *J. prakt. Chem.*, [2] **9**, 1 (1874).
7. GOCKEL: *Angew. Chem.*, **48**, 430 (1935).
8. STOLLÉ and KRAUCH: *Ber.*, **46**, 2337 (1913).
9. LEVENE and SENIOR: *J. Biol. Chem.*, **25**, 623 (1916).
10. DAVIS: *J. Am. Chem. Soc.*, **43**, 669 (1921).
11. FRANKLIN: "Nitrogen System of Compounds," p. 89, A.C.S. Monograph, Reinhold Publishing Corporation, New York, 1935.
12. MAJRICH: *Chem. Ztg.*, **58**, 315 (1934).
13. DAVIS: *J. Am. Chem. Soc.*, **43**, 2234 (1921).
14. EWAN and YOUNG: *J. Soc. Chem. Ind.*, **40**, 109T (1921).
15. BLAIR and BRAHAM: *J. Am. Chem. Soc.*, **44**, 2342 (1922).

16. SMITH, SABETTA, and STEINBACH: *Ind. Eng. Chem.*, **23**, 1124 (1931).
17. ERLINMEYER: *Ann.*, **146**, 258 (1868).
18. RATHKE: *Ber.*, **18**, 3102 (1885).
19. BANNOW: *Ber.*, **4**, 161 (1871).
20. BLAIR and BRAHAM: *Ind. Eng. Chem.*, **16**, 848 (1924).
21. SCHMIDT: Thesis, University of Illinois (1936).
22. GOCKEL: *Angew. Chem.*, **47**, 555 (1934).

34. PHOSPHORUS PENTACHLORIDE



SUBMITTED BY R. N. MAXSON*

CHECKED BY H. S. BOOTH† AND C. V. HERRMANN†

The direct union of pure phosphorus trichloride and chlorine under controlled conditions provides a simple method for preparing a high grade of phosphorus pentachloride.

Procedure

In the diagram (Fig. 16), *A* is a tank of chlorine; *B*, a safety bottle; *C*, a bubbling bottle to observe rate of flow of chlorine gas; and *D*, a 2-l. bottle fitted with a three-hole rubber stopper. If available, a neckless jar, such as the cylindrical jars used in collecting gases, over water in elementary classes, is even better, since the solid PCl_5 is more easily scraped out.

Through one hole is placed an inverted funnel for introduction of chlorine; the stem of a dropping funnel is passed through the second hole and rests directly above the flared part of the funnel. The third hole contains an outlet tube for excess chlorine. To prevent diffusion of moisture back into the reaction chamber, small drying tubes containing calcium chloride should be placed on the end of this latter tube and also connected to the inlet of the dropping funnel. The whole apparatus should be set up in a well-ventilated hood.

* University of Kentucky, Lexington, Ky.

† Western Reserve University, Cleveland, Ohio.

Pour 50 g. of pure phosphorus trichloride in the dropping funnel. Pass a steady stream of chlorine from the tank through the apparatus until the reaction vessel is completely filled with chlorine. Let the phosphorus trichloride run in at a rate of about one drop every second. (If liquid is admitted too slowly, phosphorus pentachloride will form in the dropping tube and block it.) When the phosphorus trichloride has all been admitted, pass in

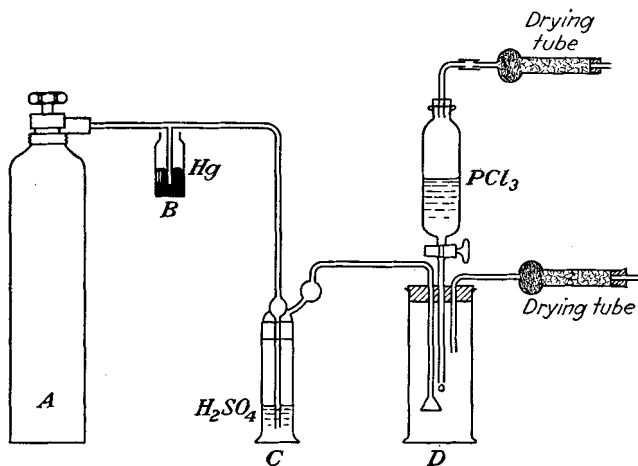

FIG. 16.—Preparation of phosphorus pentachloride.

chlorine for five minutes more and then let stand for $\frac{1}{2}$ hour to chlorinate the last traces of phosphorus trichloride. By means of a porcelain spatula, scrape out the phosphorus pentachloride into a glass-stoppered bottle which has been dried in the oven while a current of dry air was being passed into the bottle.

The yield averages 85 per cent PCl_5 based on the PCl_3 used, and the product is clear white.

Properties

Phosphorus pentachloride has a specific gravity of approximately 1.6 at room temperature, melts at 148°C . under pressure, and sublimes at 160°C . It is soluble in carbon disulfide and benzoyl chloride.

35. CRYSTALLINE ORTHOPHOSPHORIC ACID

SUBMITTED BY ARTHUR G. WEBER*,† AND G. B. KING†,‡
CHECKED BY LAURENCE L. QUILL§ AND WILFORD H. THOMAS§

Orthophosphoric acid of a high degree of purity may be prepared by crystallizing the acid from concentrated solutions. These solutions are obtained by removing water from ordinary syrupy phosphoric acid at low temperature and pressure. This concentration must be performed with care, since the incomplete removal of water results in the

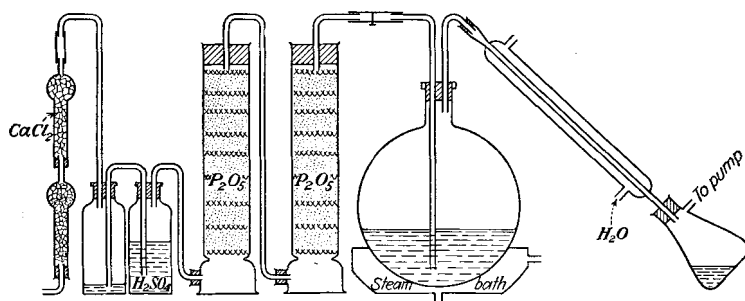

FIG. 17.—Preparation of crystalline orthophosphoric acid.

formation of the hemihydrate $2\text{H}_3\text{PO}_4 \cdot \text{H}_2\text{O}$ (m. 30°C .), whereas temperatures above 100°C . cause a partial conversion of the orthophosphoric acid into pyrophosphoric acid.

Procedure

Place 5 lb.** of 85 per cent commercial syrupy orthophosphoric acid in a 5-l., round-bottom flask equipped with a condenser and suction flask and arranged, as shown in Fig. 17, in such a way that air dried by conducting it

* E. I. du Pont de Nemours and Company.

† Washington State College, Pullman, Wash.

‡ The authors wish to acknowledge the assistance of Prof. J. H. Walton, University of Wisconsin, Madison, Wis., under whose direction the major portion of this work was conducted.

§ The Ohio State University, Columbus, Ohio.

** The authors have started with as small an amount as 2 lb. with satisfactory results.

through concentrated sulfuric acid and drying towers of phosphorus pentoxide may be bubbled through the acid by means of a capillary tube extending into the liquid. During the distillation, heat by means of a steam bath, and draw dry air through the liquid continuously at low pressure. The dry air not only greatly facilitates the removal of water but also keeps the acid thoroughly agitated. The greater portion of the water distills readily at the pressure that can be produced with a water-aspirator pump. For removing the remaining portion, it is necessary to maintain a pressure of 1 to 3 mm. by means of a mechanical vacuum pump. Thirty-six to forty hours is required to concentrate the acid.

To crystallize the concentrated residue, seed with a crystal of the acid, obtained by supercooling a portion of the concentrated acid in an ice bath. The temperature should be maintained at about 30°C. throughout the crystallization.

After approximately one-third of the material has crystallized, drain the mother liquor from the crystals in an anhydrous atmosphere.* To obtain a very dry acid, recrystallization is necessary. Dry the solid acid by drawing very dry air at low pressure through the crystals for several days.

The yield is practically 100 per cent based on the weight of H_3PO_4 , since the acid drained from the crystals may be added to a subsequent portion to be concentrated without altering the quality of the product.

The final product prepared in this manner has a melting point of 42.35 to 42.45°C. The melting point is determined by taking the temperature at which the last crystal disappears when the material is heated at a rate of 1° each 2 hours under a blanket of dry air. Slow heating and

* In draining the mother liquid from the crystals, with the 5-lb. batches, the authors employ a cylindrical jar, about 18 in. high and 9 in. in diameter, fitted with a ground-glass top. With P_2O_5 in a crystallizing dish in the bottom, this serves as a desiccator. For small amounts, large desiccators will serve.

rapid stirring are necessary while taking melting points because of the low heat conductivity of the acid.

Reference

For a discussion of the hydrates of orthophosphoric acid, see SMITH and MENZIES: *J. Am. Chem. Soc.*, **31**, 1183 (1909).

36. ARSENIC TRIIODIDE

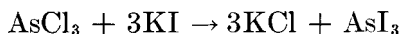

SUBMITTED BY JOHN C. BAILAR, JR.*

CHECKED BY W. C. JOHNSON† AND ALBERT G. CHENICEK†

Arsenic triiodide has been prepared by direct union of the elements with or without a solvent,¹ by the reaction of iodine with arsenic trioxide² or sulfide,³ and by the reaction of aqueous solutions of an arsenic compound and an iodide.⁴ The last mentioned furnishes the most convenient method of obtaining the material in pure form.

Procedure

A solution of 14 g. of arsenic trioxide in 200 ml. of concentrated hydrochloric acid is mixed with a solution of 70 g. of potassium iodide in 70 ml. of water. The precipitate of arsenic triiodide is allowed to stand in the solution for four or five minutes and is then filtered off and dried. It is purified from adhering potassium chloride by dissolving it in carbon disulfide and evaporating the solvent. Yield of pure crystalline material, 57 g. (90 per cent).

Properties

Arsenic triiodide commonly crystallizes in orange-red leaflets which show some tendency to sublime below 100°C. and melt to a red liquid at 149°C. The boiling point is about 400°C. Arsenic triiodide is readily soluble in carbon disulfide, chloroform, benzene, toluene, and xylene and less so in alcohol, ether, and water. It does not

* University of Illinois, Urbana, Ill.

† University of Chicago, Chicago, Ill.

hydrolyze rapidly and may be recovered from the water solution unchanged. It reacts slowly with the oxygen of the air, liberating iodine.

References

1. (a) DUNCAN: *Pharm. J.*, [4] **18**, 8 (1904); (b) COWLEY and CATFORD: *Pharm. J.*, [4] **21**, 131 (1905); (c) NICKLES: *Compt. rend.*, **50**, 872 (1860); (d) BAMBERGER and PHILIPP: *Ber.*, **14**, 2643 (1881); (e) FISK: *Am. Mineral.*, **15**, 263 (1930).
2. (a) BRAME: *Compt. rend.*, **33**, 579 (1851); (b) RICHTER: *Apoth. Zeit.*, **26**, 728, 742 (1911).
3. SCHNEIDER: *J. prakt Chem.*, [2] **34**, 505 (1886); [2] **36**, 498 (1887).
4. (a) BAMBERGER and PHILIPP: *loc. cit.*; (b) PATERNOSTO: *Rev. facultad cienc. quim. (Univ. LaPlata)*, **7**, 43-46 (1930); *Chem. Abstr.*, **25**, 45 (1931).

37. ANTIMONY TRIIODIDE

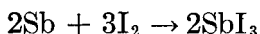

SUBMITTED BY JOHN C. BAILAR, JR.,* AND PAUL F. CUNDY*
 CHECKED BY W. C. JOHNSON† AND S. WEINHOUSE†

Antimony triiodide was first prepared¹ by warming the constituent elements together, but this method of preparation is very unsatisfactory owing to the extreme violence of the reaction. Nickles² has moderated the reaction by dissolving the iodine in carbon disulfide. Experience has shown that it is difficult to make the reaction go to completion under these conditions, and the product always requires purification. Other methods involve the substitution of iodine for sulfur in antimony trisulfide³ and the interaction of acetone solutions of potassium iodide and antimony trichloride.⁴ None of these methods gives a pure product. The procedure outlined below is simple and gives a pure crystalline product.

Procedure

Twenty grams of antimony powder is suspended in 1 l. of boiling benzene in a flask fitted with a reflux condenser.

* University of Illinois, Urbana, Ill.

† University of Chicago, Chicago, Ill.

A vigorous ebullition must be maintained so that the antimony does not form a cake on the bottom of the flask. A slight excess of solid iodine is added a little at a time through the condenser. The first portions of the iodine are decolorized almost instantly, but toward the end the reaction proceeds much more slowly. Before the addition is complete, fine red crystals of antimony triiodide begin to form. The boiling should be continued for half an hour to insure complete reaction. On cooling the material, the iodide that was still in solution crystallizes in beautiful hexagonal plates. Yield 64 g. (80 per cent). By concentrating the mother liquor, additional crystals can be obtained. This second crop is contaminated with iodine, most of which may be removed by washing the crystals with carbon tetrachloride, in which antimony triiodide is insoluble.

If mechanical stirring is provided, this method can be used for the preparation of much larger amounts of the material.

Properties

Antimony triiodide forms beautiful ruby-red crystals which are soluble in carbon disulfide, benzene, alcohol, and acetone. The tendency to sublime becomes noticeable at temperatures as low as 100°C., but the melting point and boiling point are 166°C. and about 400°C., respectively.

Antimony triiodide reacts rapidly with moisture to give an oxyiodide. The same compound is formed by long exposure to dry air, part of the iodine being displaced by oxygen.

References

1. SERULLAS: *J. pharm. chim.*, [2] **14**, 19 (1828); BERTHEMOT: *J. pharm. chim.*, [2] **14**, 615 (1828).
2. NICKLES: *J. pharm. chim.*, [3] **41**, 147 (1862).
3. SCHNEIDER: *Pogg. Ann.*, **109**, 610 (1860); ODDO and GIACHERY, *Gazz. chim. ital.*, **53**, 56 (1923).
4. NAUMANN: *Ber.*, **37**, 4333 (1904).

38. HYPOVANADOUS OXIDE AND VANADIUM OXYTRICHLORIDE

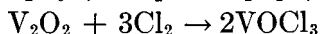
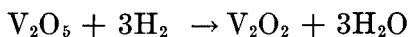

SUBMITTED BY F. E. BROWN* AND F. A. GRIFFITTS†

CHECKED BY G. B. HEISIG‡ AND L. A. ENBERG‡

The classical laboratory method for preparing vanadium oxytrichloride is the reduction of vanadium pentoxide by means of hydrogen and subsequent chlorination of the lower oxide. These processes are carried out in glass tubes at a low temperature. If the temperature during chlorination becomes too high, the oxide softens, fuses to the glass, cakes, and much of the oxide escapes chlorination and often causes the glass to break. These difficulties are avoided by mixing finely powdered charcoal (Norite) with the hypovanadous oxide before chlorination. The role of the carbon is not known, but it is not consumed in the process.

A. HYPOVANADOUS OXIDE

A pyrex tube 100 cm. long and about 2.5 cm. in diameter is filled to one-third of its capacity with vanadium pentoxide. After the air has been displaced with hydrogen, the tube and its contents are heated to a dull-red heat. A slow stream of hydrogen is allowed to flow until the mixture in the tube becomes black. Heating is then discontinued, but hydrogen is passed through the tube until its contents are cool.

B. VANADIUM OXYTRICHLORIDE

The black oxide of vanadium is mixed with an equal weight of Norite which has been activated and dried by heating to as high a temperature as possible without ignition. The pyrex tube is refilled with the dried mixture so

* Iowa State College, Ames, Iowa.

† Maryville College, Maryville, Tenn.

‡ University of Minnesota, Minneapolis, Minn.

that only a sufficient space is left for a free flow of chlorine above the charge. The air in the tube is displaced with dry chlorine, and the flow of the gas continued while heat is applied by moving a Fisher or Meker burner along the top of the tube. A temperature below redness is sufficient. The liquid that distills from the tube is collected in a distilling flask immersed in an ice-salt mixture. The contents of the tube should be protected from moisture by a drying tube attached to the side arm. Provision must be made for disposal of the excess of chlorine. Yield 80 g. (71 per cent of theory).

Purification

The product is colored red by the presence of vanadium tetrachloride and contains considerable dissolved chlorine. These impurities may be removed by fractional distillation followed by a distillation from metallic sodium. The last few milliliters of vanadium oxytrichloride should not be removed from the sodium by a direct flame, as superheating often causes an explosion. A fractionating udder is convenient for collecting the product without exposing it to the moisture in the air. The side tube should be connected to a drying tube. Yield 70 g. (87 per cent of theory); boiling point 124.5 to 125.5° at 744 mm.

Properties

Vanadium oxytrichloride is a lemon-yellow liquid. Its boiling point is 124.5°C. at 736 mm. and 127.16°C. at 760 mm. It remains liquid at -77° . The vapor pressure at -77° is 4.1 mm.; at 0° , 21 mm.; and at 85° C., 270 mm. Its density in grams per milliliter is 1.854 at 0° and 1.811 at 32° C. At ordinary temperatures, it neither dissolves nor reacts with carbon, hydrogen, nitrogen, oxygen, silicon, tellurium, or metals except the alkali metals and antimony. The reactions with the alkali metals are explosive at characteristic temperatures, varying from 30° C. for cesium to 180° C. for sodium (lithium not determined). Small

proportions of white phosphorus dissolve without apparent reaction, but large proportions react explosively. Arsenic and antimony react much less vigorously, and red phosphorus does not react. Sulphur, the halogens, and many organic compounds are soluble in vanadium oxytrichloride. Paraffin compounds and their halogen substitution products are usually miscible in all proportions without reaction. Aldehydes react vigorously. Vanadium oxytrichloride reacts with the smallest traces of water to produce a red-colored solid.

CHAPTER VI

39. OXYGEN FLUORIDE



SUBMITTED BY DON M. YOST*

CHECKED BY GEORGE H. CADY†

The preparation of this substance consists in passing gaseous fluorine through a 2 per cent solution of sodium hydroxide.^{1,2,3} The product obtained is a mixture consisting of approximately 50 per cent OF_2 and 50 per cent O_2 , together with small amounts of fluorides of carbon (from the fluorine generator).

Procedure

The sodium hydroxide solution from a large bottle, and at room temperature, is caused to flow at the rate of 1 l. per hour through a pyrex glass tube equipped with an overflow for the solution and another tube for the gas outlet, and an inlet tube of copper or platinum for the fluorine as shown in Fig. 18. The inlet tube, which is sealed into the glass with red sealing wax, dips from 0.5 to 2 cm. into the alkali solution. The fluorine is passed directly from the generator into the inlet tube at the rate of from 1 to 3 l. per hour. If the fluorine is first condensed with liquid air, the yield is said to be very small.² To the exit tube are attached first a gas wash bottle filled with water, (see Fig. 19) then a trap cooled with a solid carbon dioxide-alcohol mixture, and finally another trap cooled with liquid air. The OF_2 is freed from any fluorine in the wash bottle, and the water vapor is frozen out in the first trap. The $\text{OF}_2\text{—O}_2$ mixture condenses to a pale-yellow liquid in the

* California Institute of Technology, Pasadena, Calif.

† University of Washington, Seattle, Wash.

liquid-air trap. The mixture may be evaporated into a dry glass balloon and stored there until needed.

Further purification can be accomplished by pumping on the trap containing the liquid while it is still immersed

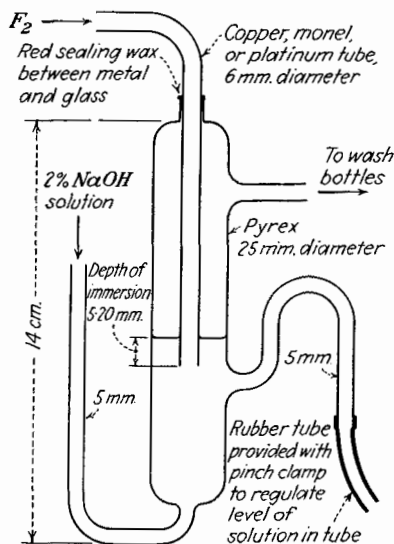

FIG. 18.—Generator for oxygen fluoride.

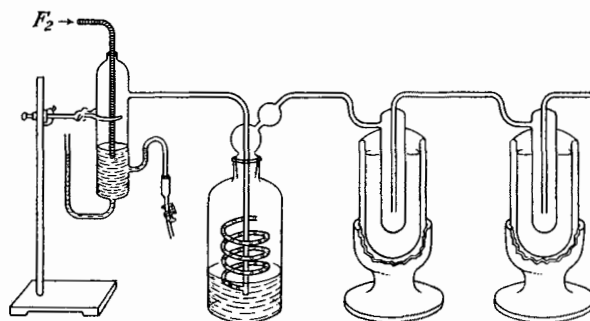

FIG. 19.—Train for preliminary purification of oxygen fluoride.

in liquid air. A water pump is best, since the gas coming off (principally oxygen at first) will eventually cause loud, but not damaging, explosions if it comes in contact with the oil of an oil-filled pump. By this procedure a mixture containing some 85 mol per cent of oxygen fluoride may be

obtained. Further purification must be carried out by fractional distillation at low temperatures.

Properties

When pure, oxygen fluoride is a colorless gas which melts at -223.8°C . and boils at -144.8°C . Its heat of formation is about -7000 cal.; and its heat of vaporization, -2508 cal. $\Delta F^{\circ}_{298} \approx 11,000$ cal. from O_2 and F_2 , and $S^{\circ}_{298} \approx 58$ cal. per degree. The solubility of oxygen fluoride in 100 ml. water at 0° and 1 atm. is 6.8 ml.

The gas does not attack dry glass or quartz at ordinary temperatures, and it does not decompose except at elevated temperatures. Mercury is attacked at room temperatures, and when used in manometers it soon becomes so fouled that the level cannot be seen. Stopcock grease is slowly attacked.

References

1. LEBEAU and DAMIENS: *Compt. rend.*, **188**, 1253 (1929).
2. RUFF and MENZEL: *Zeit. anorg. allgem. Chem.*, **190**, 257 (1930); **198**, 39 (1931).
3. CADY: *J. Am. Chem. Soc.*, **57**, 246 (1935).

40. LIQUID HYDROGEN SULFIDE

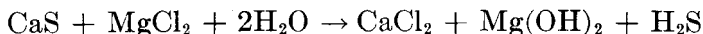

SUBMITTED BY W. D. BICKFORD* AND J. A. WILKINSON*
CHECKED BY E. R. CALEY† AND P. J. ELVING†

The usual method for the preparation of hydrogen sulfide from iron sulfide and hydrochloric acid is somewhat difficult to control and is open to the possible objection that other volatile acids such as sulfurous or even the hydrochloric may be carried over with the hydrogen sulfide. To

* Iowa State College, Ames, Iowa.

† Princeton University, Princeton, N. J.

obviate this, Habermann¹ and Randall and Bichowsky² developed a method involving the reaction of calcium sulfide, magnesium chloride, and water. This method, with modifications to allow the condensation of the hydrogen sulfide, is outlined below.

Procedure

The entire procedure should be carried out in a hood.* The apparatus used is shown in Fig. 20. The barium

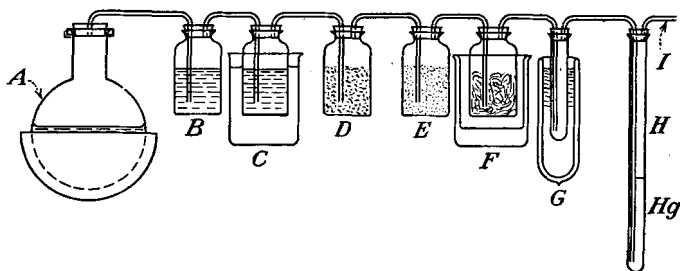

- A 2 L. R.B. flask with water bath.
 B 250 ml. gas bottle containing water.
 C 250 ml. gas bottle containing saturated barium hydroxide solution, cooled with an ice-salt bath.
 D 250 ml. gas bottle containing calcium chloride.
 E 250 ml. gas bottle containing phosphorus pentoxide.
 F 250 ml. gas bottle with glass wool cooled with solid carbon dioxide in double beakers with cotton between them.
 G 50 ml. test tube cooled with solid carbon dioxide-ether mixture in a Dewar flask.
 H Large tube of mercury for regulating the pressure.
 I Outlet to hood.

Fig. 20.—Apparatus for preparation of liquid H_2S .

hydroxide in *C* absorbs the first portion of the hydrogen sulfide and is converted to barium hydrosulfide. Thereafter, the hydrogen sulfide passes through, but other volatile acids are retained. The precooling bottle *F* is helpful in obtaining a high yield of liquid hydrogen sulfide.

Ten grams of magnesium chloride and 50 g. of good-quality calcium sulfide† are added to 500 ml. of a saturated

* Hydrogen sulfide is of the order of toxicity of cyanogen and hydrocyanic acid. Some persons are much more susceptible to it than others. The U. S. Bureau of Mines reports 0.06 to 0.08 per cent as causing acute poisoning and 0.005 per cent as causing subacute poisoning, when mixed with air.

† Calcium sulfide deteriorates readily. The commercial product is about 85 per cent pure when prepared but may contain only a few per cent when used.

solution of magnesium chloride in the generating flask. When the mixture is heated to 60°C., the evolution of hydrogen sulfide is regular and continuous. Time may be saved if the pressure supplied by the mercury trap *H* is not applied until the air has been swept from the apparatus. The first run gives a low yield because some of the hydrogen sulfide is used in filling the apparatus. Under proper conditions, subsequent runs may yield as much as 19 g. (80 per cent), and several hundred milliliters of liquid may be obtained in the course of a day.

Properties

Hydrogen sulfide is a poisonous gas of density 0.96, melting point -82.9°C., boiling point -59.4°C., critical temperature 100.5°C., critical pressure 89 atm., surface tension 25.43 dynes, specific conductance 0.2×10^{-9} , dielectric constant 8.6, and viscosity 0.0041 dyne per centimeter.

References

1. HABERMANN: *Chem. Zentr.*, [4] **2**, i, 82 (1890).
2. RANDALL and BICHOWSKY: *J. Am. Chem. Soc.*, **40**, 373 (1918).

41. THIONYL BROMIDE

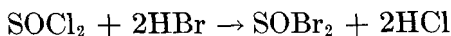

SUBMITTED BY HAROLD HIBBERT* AND J. C. PULLMAN*

CHECKED BY H. S. BOOTH† AND CLARENCE SEABRIGHT†

Thionyl bromide has been prepared by the action of hydrogen bromide on thionyl chloride¹ and also by replacing the hydrogen bromide with sodium bromide or aluminum bromide.² Recently a thorough investigation³ on the preparation of thionyl bromide was carried out, and the use of hydrogen bromide on thionyl chloride was found to be the most advantageous. However, in all cases a large portion of unchanged thionyl chloride was mixed with the thionyl bromide and necessitated considerable fractionation.

* McGill University, Montreal, Can.

† Western Reserve University, Cleveland, Ohio.

The following procedure consists of passing anhydrous hydrogen bromide through cold technical thionyl chloride.

Procedure

The hydrogen bromide was prepared by mixing bromine vapor with an excess of hydrogen and passing the mixture over a glowing platinum wire or, better, over platinized silica gel (see synthesis 53). The resulting gas, free from bromine, was dried by passing through a tower containing calcium chloride and phosphorus pentoxide.

The hydrogen bromide was passed into 50 ml. of technical thionyl chloride for 12 hours at 0°C., yielding a reddish liquid which on distillation under diminished pressure in an all-glass apparatus gave 50 ml. of an orange-red liquid, boiling constantly at 69 to 70°C. at 62 mm. On redistillation, the product boiled at 48°C. at 20 mm. and was orange-yellow in color.

Analysis gave 76.68 and 76.85 per cent bromine, the theory being 76.88 per cent bromine. The yield is almost quantitative. The specific gravity by the Westphal balance method is 2.688 at 20°C. It freezes at -52°C. Thionyl bromide decomposes slowly on standing and should be kept in bottles with tight-fitting glass stoppers.

References

1. BESSON: *Compt. rend.*, **122**, 320; **123**, 884 (1896).
2. HARTOG and SIMS: *Chem. News*, **67**, 32 (1893).
3. MAYES and PARTINGTON: *J. Chem. Soc.*, 2594 (1926).

42. SULFURYL CHLORIDE

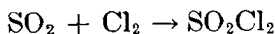

SUBMITTED BY H. R. ALLEN* AND R. N. MAXSON*

CHECKED BY H. S. BOOTH† AND C. V. HERRMANN†

Sulfuryl chloride was first prepared by Regnault¹ in 1838 by the action of chlorine on a mixture of ethylene and sulfur dioxide. The compound can also be produced by causing

* University of Kentucky, Lexington, Ky.

† Western Reserve University, Cleveland, Ohio.

chlorine to react with sulfur dioxide in the presence of camphor which acts as a catalyst. Other catalysts, such as glacial acetic acid and anhydrous formic acid, can also be employed.

Danneel² used granulated, activated charcoal as a catalyst. The method of Danneel can be readily modified to permit the production of relatively large amounts of this very important reagent.

Procedure

The apparatus of Danneel is modified as shown in Fig. 21 to include a gauge* for regulating the flow of the two gases.

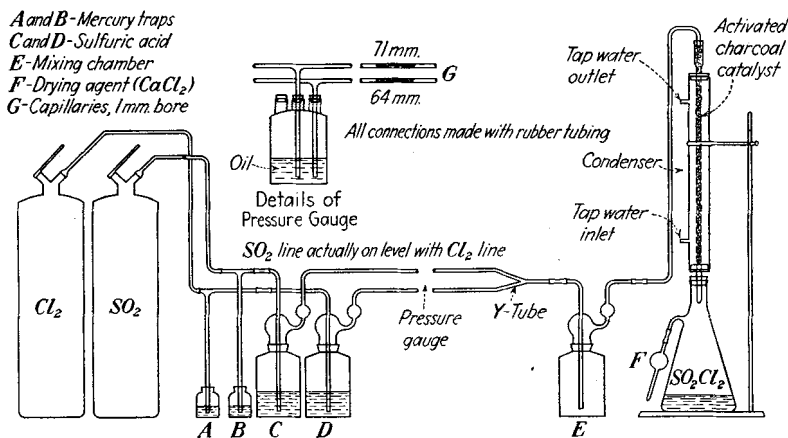

Capacity of Drechsel bottles, 250 ml.; capacity of Woulff bottle, 250 ml.; capacity of receiver for SO₂Cl₂, 1000 ml.; inside diameter of capillary tubing of gauge, 1 mm.; length of capillary tubing of gauge, 71 and 64 mm.; inside diameter of T tubes, 4 mm.; length of glass condenser tube, 80 cm.; inside diameter of glass condenser tube, 14 mm.; length of condenser jacket, 53 cm.; inside diameter of condenser jacket, 40 cm.

FIG. 21.—Preparation of sulfuryl chloride.

An ordinary, straight glass condenser is used as the reaction chamber. The advantages of this chamber are that the charcoal may be activated in the pyrex glass tube of the

* A chlorine generator can be used. Although the gauge works fairly satisfactorily under these conditions, a chlorine tank greatly improves its efficiency. Owing to inability to keep the chlorine supply from a generator at constant pressure, the flow of the sulfuryl chloride from the condenser is not regular, though the flow does not stop at any time.

condenser and that it presents a long column over which the gases must flow and thus increase the efficiency of the catalyst.

The flow of the two gases is equalized by means of a gauge, as shown on the diagram. Capillary tubes, whose lengths are inversely proportional to the specific densities of the two gases, are inserted in the respective arms of the T tubes and held in place by stoppers made of small-bore rubber tubing. When the liquid, a heavy paraffin oil, in the Woulff bottle stands at the same height in the two tubes, equal amounts of the two gases are supplied to the mixing chamber.

Equal volumes of chlorine gas and sulphur dioxide gas are passed through the respective trains, mixed, and passed through activated charcoal. The latter is contained in a straight pyrex glass condenser tube and supported in place by a plug of glass wool. The condenser jacket cooled by tap water encases the condenser tube. The sulfuryl chloride drips into the receiver attached to the condenser. The air is swept from the trains before the connection is made with the tube containing the charcoal.* The flow of the two gases is so regulated that the liquid in the T tube shanks stands at the same height. The flow should be rapid for best results. It can be so regulated that the liquid sulfuryl chloride falls into the receiver in a continuous stream.

The yield from an actual run, using 5.34 kg. of sulfur dioxide and 5.68 kg. of chlorine, was 10.45 kg. This is a yield of 96.2 per cent based on the chlorine used or 97.5 per cent based on the sulfur dioxide used.

Properties

Sulfuryl chloride is a colorless liquid with a boiling point of 69.2°C. and a specific gravity of 1.7045 at 0°C. It is stable when dry but is decomposed by water with the production of sulfuric and hydrochloric acids.

* The start of the reaction is hastened if a little sulfuryl chloride is added to the charcoal at the beginning.

Hydrolysis proceeds at low temperatures. Light decomposes the chloride with the production of chlorine. Chlorides of organic acids can be produced by the action of this substance upon salts of organic acids,

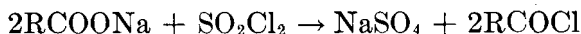

References

1. REGNAULT: *Ann. chim. phys.*, [2] **69**, 170 (1838).
2. DANNEEL: *Z. angew. Chem.*, **39**, 1553 (1926).

43. SELENIUM DIOXIDE

Selenium dioxide, unlike sulfur dioxide, is not readily prepared by direct combination of the elements. The best methods depend upon combustion of selenium in the presence of nitrogen dioxide¹ or oxidation of selenium by nitric acid.² The first method includes purification by sublimation; the second gives a pure product only if the selenium is pure or if the product is sublimed.

A. BY COMBUSTION OF SELENIUM IN OXYGEN AND NITROGEN DIOXIDE

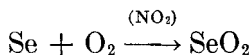

SUBMITTED BY CHARLES R. NAESER*

CHECKED BY CARL GROTHUES† AND G. B. L. SMITH†

The apparatus used is shown in Fig. 22. One hundred grams of selenium is placed in the closed end of the tube. Nitrogen dioxide and oxygen, dried by calcium chloride, are introduced through the Y tube. Some regulation of the rate of gas flow is necessary to secure best results. The gases must be thoroughly mixed before coming in contact with the selenium. It is best to use separate drying tubes for each gas, as the nitrogen dioxide contains a great deal of moisture and the calcium chloride must be changed fre-

* University of Illinois, Urbana, Ill.

† Polytechnic Institute of Brooklyn, Brooklyn, N. Y.

quently. If a stopcock is placed between the nitrogen dioxide drier and the Y tube, the calcium chloride may be changed without interrupting the flow of oxygen or the heating.

When all of the air and moisture have been displaced from the tube, the selenium is strongly heated with a Bunsen flame. A white deposit of selenium dioxide forms on the surface of the selenium; but as soon as the temperature has become high enough, it sublimes away. At the same time, the remaining selenium melts to a viscous mass and eventually burns with a pale-blue flame. The sublimate collects on the gas-delivery tube and on the sides of

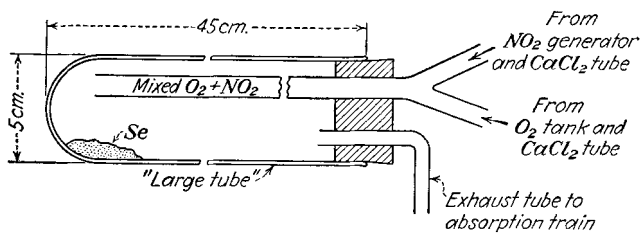
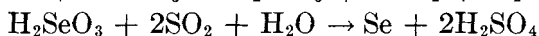

FIG. 22.—Synthesis of selenium dioxide.

the large tube. The exit gases are bubbled through water and then through sodium hydroxide to catch the oxides of nitrogen. After all of the selenium has reacted, the contents of the tube are allowed to cool while oxygen is still passing through the apparatus, and the selenium dioxide is removed.

A yield of 114 g. (80 per cent) is readily obtained by this method. There is always some loss of selenium due, perhaps, to the formation of the suboxide. Naturally, the presence of tellurium as an impurity in the starting material also decreases the yield. Tellurium remains in place, presumably as the oxide, as it is not readily volatilized.

The selenium dioxide is obtained in the form of a snow-white product, which may be kept in a tightly stoppered bottle for an indefinite length of time. On exposure to air, it may turn pink as the result of reduction (by dust).

B. BY OXIDATION OF SELENIUM BY NITRIC ACID

SUBMITTED BY R. H. BAKER* AND R. N. MAXSON*

CHECKED BY LOUIS LENTO, JR.,† AND G. B. L. SMITH‡

Place 100 ml. of concentrated nitric acid in a casserole (or evaporating dish) on a sand bath. Apply heat to the sand bath. At the same time add crude selenium cautiously in small portions until a total of 60 g. has been used. The selenium should be scattered over the surface of the acid, and the frothing allowed to subside after each addition before more selenium is added. By the time the reaction is completed, the sand bath should be at such a temperature that evaporation will have started. Continue heating until the residue appears to be dry.‡

The residue may now be subjected to further purification either by a wet-way treatment or by resublimation according to Lenher.¹

Wet-way Purification

Treat the residue with enough water to bring the selenium dioxide into solution, and, after filtering, treat with 10 ml. of concentrated hydrochloric acid. Pass a slow stream of sulfur dioxide into the solution until heat is no longer evolved. This requires 2 to 5 hours.§ Red selenium is deposited but changes to a pasty gray form which becomes brittle after standing for a few hours. Boiling at this point accelerates the change.

* University of Kentucky, Lexington, Ky.

† Polytechnic Institute of Brooklyn, Brooklyn, N. Y.

‡ Care must be taken in the evaporation and the subsequent cooling to keep the mass broken in order to avoid the formation of a hard compact mass.

§ When the red precipitate settles to the bottom in a coherent mass, the action is complete.

Remove the selenium by filtration, grind in a mortar, wash free from acid, dry and finally heat over a Bunsen burner. When the mass has cooled, dissolve it in nitric acid, and evaporate as before. To insure complete removal of the nitric acid, dissolve the residue in 75 ml. of water, and evaporate again. Yield about 76 g. of white selenium dioxide (90 per cent).

Purification by Resublimation

Pulverize the crude selenium dioxide, contaminated with impurities of copper and the other heavy metals that may have been present in the ore from which the selenium was obtained, and place in an evaporating dish. Moisten the selenium dioxide with a small amount of nitric acid, invert two nested funnels over the evaporating dish, the larger funnel having a plug of glass wool in its neck, and heat with an open flame. (One funnel may be used, but the percentage yield is decreased.) The material sublimes at 317°C.; and upon striking the funnels, which are considerably cooler, it solidifies into long needle-like crystals. The melting point of the resublimed selenium dioxide, taken in a sealed tube, agrees with that found in the International Critical Tables, *i.e.*, 340°C.

According to A. P. Julien,² resublimed selenium dioxide contains 0.045 to 0.088 per cent of water after having been desiccated over phosphorus pentoxide for as long as 12 months.

References

1. LENHER: *J. Am. Chem. Soc.*, **20**, 559 (1898).
2. JULIEN: *J. Am. Chem. Soc.*, **47**, 1799 (1925).

44. SULFUR, SELENIUM, AND TELLURIUM HEXAFLUORIDES

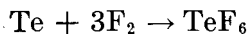
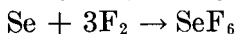
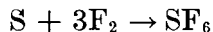

SUBMITTED BY DON M. YOST*

CHECKED BY J. H. SIMONS†

The preparation of the hexafluorides of sulfur, selenium, and tellurium consists in passing gaseous fluorine over the elementary substances.

Procedure

The sulfur, selenium, or tellurium in a moderately finely divided state is placed in a copper tube provided with an outlet and inlet. The outlet is connected to a train consisting of a trap cooled in a concentrated hydrochloric acid-ice mixture and then another immersed in liquid air or a solid carbon dioxide-alcohol mixture. Fluorine (synthesis 51) is passed into the inlet at the rate of 1 to 3 l. per hour. The reaction proceeds smoothly. The lower fluorides are condensed to a large extent in the hydrochloric acid-ice cooled trap, and the material collected in the liquid air or solid carbon dioxide trap consists principally of hexafluorides.

Sulfur hexafluoride may be passed through water, dried over phosphorus pentoxide, and further purified by repeated sublimation of the solid at low temperatures and pressures. Selenium and tellurium hexafluoride are best purified by repeated sublimation at the temperature of solid carbon dioxide, care being taken to cause the middle fraction to melt after each sublimation. The less volatile impurities consist principally of lower fluorides (tetrafluorides).

* California Institute of Technology, Pasadena, Calif.

† Pennsylvania State College, State College, Pa.

Properties

All of these hexafluorides are white solids, colorless liquids, or colorless gases.

	M.	Subl. pt.	Heat of formation, cal.	S [°] ₂₉₈	F [°] ₂₉₈ , cal. (from elements)
SF ₆	-50.8°	-63.8°	262,000	69.5	-237,400
SeF ₆	-46.6°	-46.6°	246,000		
TeF ₆	-38.9°	-38.9°	315,000		

The hexafluorides sublime before melting. They do not attack glass at ordinary temperatures. Selenium and tellurium hexafluorides attack glass at or near the softening point, and the latter decomposes water. Sulfur hexafluoride does not attack mercury, but selenium and tellurium hexafluorides do. In the gaseous state, all transmit ultraviolet light up to the short-wave-length limit of the quartz spectrograph.

References

1. SCHUMB and GAMBLE: *J. Am. Chem. Soc.*, **52**, 4302 (1930).
2. YOST and CLAUSSEN: *J. Am. Chem. Soc.*, **55**, 885 (1933).

45. CHROMOUS ACETATE

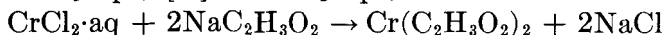
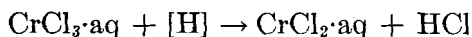

SUBMITTED BY J. H. BALTHIS, JR.,* AND JOHN C. BAILAR, JR.*

CHECKED BY FREDERIC B. DUTTON†

Of the chromous salts, the acetate is the most readily prepared and purified. Because of this fact and the fact that it reacts readily with acids, it is commonly used as the starting point for the preparation of other chromous compounds.

* University of Illinois, Urbana, Ill.

† Baldwin-Wallace College, Berea, Ohio.

The preparation of chromous acetate, as it is usually carried out,^{1,2} depends upon the insolubility of the salt in cold water. Its preparation is sometimes troublesome because chromous compounds are *extremely sensitive* to atmospheric oxidation.

Procedure

The apparatus is set up as indicated in Fig. 23. Filter *A* is about a centimeter in diameter and is loosely packed

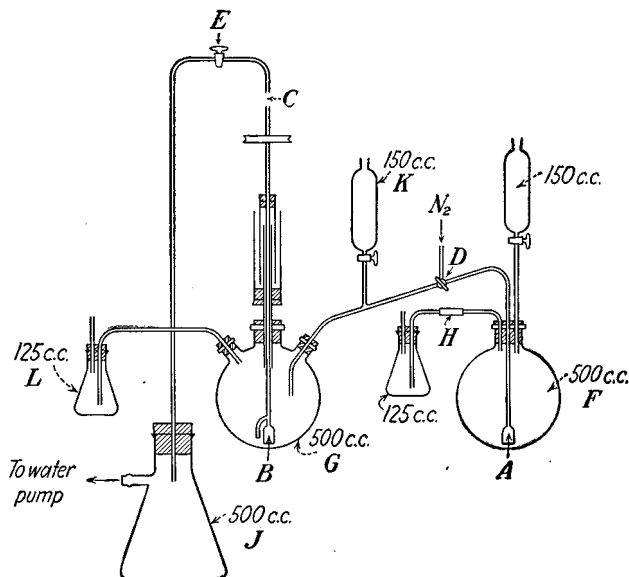

FIG. 23.—Preparation of chromous acetate.

with glass wool. The combination stirrer-filter is constructed of thick-walled tubing. To this is sealed a short piece of 1-cm. tubing which is packed with glass wool for filtering* and also a glass-rod side arm. The filter flask *J* is attached at *C* by a rubber tube only when filtering. When stirring, the rubber connection is left attached to the stirrer and is closed by a short piece of glass rod.

The reaction flask is kept filled with nitrogen (which enters at *D* and escapes at *L*) during the entire preparation.

* A sintered-glass filter may be used but it makes filtration very slow.

The nitrogen is entirely freed from oxygen by bubbling it through towers filled with pyrogallol and ammoniacal cuprous chloride. The easiest method of insuring complete removal of air from the reaction flask is to fill it with freshly boiled water, which is then forced out through *J* by the nitrogen.

Thirty grams of hydrated chromic chloride, dissolved in 35 ml. of water, and 50 g. of zinc are put in flask *F*. Seventy milliliters of concentrated hydrochloric acid is then allowed to drip upon the mixture, and the chromic chloride is reduced to bright-blue chromous chloride. When the evolution of hydrogen has slackened, stopcock *D* is turned, and the rubber connection *H* is closed so that the pressure of the hydrogen forces the solution into the flask *G*.

A filtered solution of 84 g. of sodium acetate in 100 ml. of water is now introduced into the reaction flask through the funnel *K*, and the mixture is stirred for a short time. The liquid is filtered off, and the precipitate is washed with freshly boiled distilled water. If the chromous acetate is to be removed from the reaction flask, it must be thoroughly dried before exposure to the air, as it oxidizes much more rapidly when moist than when dry. The drying is carried out by washing the precipitate with alcohol and ether, the last traces of ether being removed by the stream of nitrogen.

The yield is 17.5 g., or 91 per cent, based on $\text{CrCl}_3 \cdot 6\text{H}_2\text{O}$. The time of preparation, not including that required for drying the product, is one hour.

Properties

Chromous acetate is a deep-red powder, slightly soluble in cold water but readily soluble in hot water. It dissolves in and reacts with most acids. Even in the dry condition, it absorbs oxygen from the air.

References

1. ERDMAN: *Lehrbuch der anorg. Chem.*, 2nd. ed. (1900), p. 628.
2. PELIGOT: *Ann. chim. phys.*, [3] **12**, 528 (1844).

46. CHROMOUS CHLORIDE

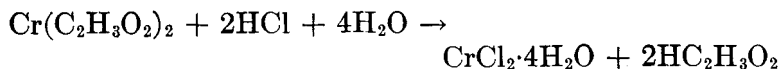

SUBMITTED BY J. H. BALTHIS, JR.,* AND JOHN C. BAILAR, JR.*

CHECKED BY FREDERIC B. DUTTON†

The only satisfactory methods of obtaining chromous chloride depend either upon electrolytic reduction of chromic chloride solutions¹ or upon the conversion of chromous acetate to the chloride.^{2,3} The anhydrous salt may be obtained by the action of hydrogen chloride gas upon heated chromium^{4,5} or by the reduction of anhydrous chromic chloride by means of hydrogen.⁶ The electrolytic reduction is slow and gives only a solution of chromous chloride. The preparations in the dry way require high temperatures, and the preparation of large amounts of material by them is inconvenient.

Procedure

The apparatus used for the preparation of chromous acetate (see synthesis 45) is used in the preparation of chromous chloride, the only change being the addition of another three-way stopcock to the nitrogen-inlet tube (Fig. 23). This makes it possible to introduce either nitrogen or hydrogen chloride, or both, to the reaction flask. Care must be taken to remove *all traces of air* from the hydrogen chloride generator and connections before the preparation is begun.

Chromous acetate is made as described in synthesis 45 and is cooled to 0°C. by immersing the reaction flask in an ice-salt mixture. The chromous acetate is dissolved in 60 ml. of previously cooled concentrated hydrochloric acid with stirring. A current of hydrogen chloride gas (see synthesis 52) is now passed through the flask along with the nitrogen for about one hour. Unless the current is

* University of Illinois, Urbana, Ill.

† Baldwin-Wallace College, Berea, Ohio.

steady, water will be drawn back into the reaction flask from the safety flask. Blue $\text{CrCl}_2 \cdot 4\text{H}_2\text{O}$ precipitates in the cooled flask. The excess liquid is filtered off, and the precipitate is washed with 20 ml. of cooled concentrated hydrochloric acid. The $\text{CrCl}_2 \cdot 4\text{H}_2\text{O}$ may be dried by washing with acetone, but complete drying is difficult because the acetone evaporates slowly. The $\text{CrCl}_2 \cdot 4\text{H}_2\text{O}$ oxidizes quickly when exposed to air, but in the flask, it is stable for some time.

The yield is about 17 g., or 80 per cent, based on 30 g. of $\text{CrCl}_3 \cdot 6\text{H}_2\text{O}$ as the starting material. The time required for the complete preparation from $\text{CrCl}_3 \cdot 6\text{H}_2\text{O}$ is $2\frac{1}{2}$ hours.

Properties

Chromous chloride tetrahydrate prepared at low temperatures is a bright blue crystalline substance, soluble in water but almost insoluble in cold concentrated hydrochloric acid. Above 38°C ., it changes into an isomeric green modification which loses water at 51°C . with the formation of the trihydrate. Chromous chloride absorbs oxygen from the air even when dry, forming a greenish-black oxychloride. On standing in solution, it is oxidized by the water, with the liberation of hydrogen. This change is catalyzed by acids⁷ and bases and by the presence of platinum⁷ and palladium.⁸

References

1. TRAUBE and GOODSON: *Ber.*, **49**, 1679 (1916).
2. KNIGHT and RICH: *J. Chem. Soc.*, **99**, 87 (1911).
3. RECOURA: *Ann. chim. phys.*, [6] **10**, 10 (1887).
4. KOPPEL: *Z. anorg. Chem.*, **45**, 361 (1905).
5. UFER: *Ann.*, **112**, 302 (1859).
6. MOBERG: *J. prakt. Chem.*, [1] **29**, 175 (1843).
7. ASMANOV: *Z. anorg. allgem. Chem.*, **160**, 209 (1927).
8. TRAUBE and LANGE: *Ber.*, **58**, 2773 (1925).

47. SILICOMOLYBDIC ACID

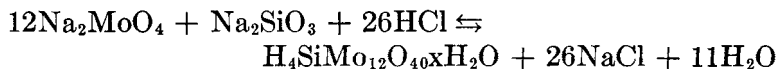

SUBMITTED BY E. O. NORTH* AND WILLIAM HANEY*
CHECKED BY JOHN C. BAILAR, JR.†

The preparation of silicomolybdic acid is based on a hydrolytic reaction similar to that used in the preparation of silicotungstic acid. (See synthesis 48.) Only a few modifications are necessary to avoid the precipitation or reduction of molybdic acid.

The properties of silicomolybdic acid are like those of silicotungstic acid. Toward indicators having a pH of 5 to 6 it behaves as a tetrabasic acid. With phenolphthalein as the indicator it requires eight equivalents for titration in cold solution but twenty-four equivalents for titration at 100°C. With tertiary organic bases it is tetrabasic.

The acid prepared by the following directions has about six molecules of water of hydration. Illingsworth and Keggin¹ believe that the X-ray photographs show the pentahydrate cubic packing. As in the case of silicotungstic acid, the amount of water of hydration is usually not important. The concentration of a solution of silicomolybdic acid can be determined by titration with a standard alkali or by evaporation followed by careful ignition.

Procedure²

Fifty grams‡ of sodium molybdate is dissolved in 200 ml. of water, and the solution heated to 60°C. To this solution is added 20 ml. of concentrated hydrochloric acid (density 1.18). The mixture is stirred vigorously with a

* University of North Dakota, Grand Forks, N. D.

† University of Illinois, Urbana, Ill.

‡ This preparation is not easily carried out with large amounts of material. Small multiples of the amounts indicated have been used successfully; but when kilogram lots are used, troublesome precipitations often occur.

motor stirrer while 5 g. of water glass (density 1.375) dissolved in 50 ml. of water is added. While the stirring is continued, 60 ml. of concentrated hydrochloric acid is added dropwise from a separatory funnel. The slight precipitate of silicic acid is filtered off through a glass wool-asbestos filter. The filtrate is cooled and extracted with a slight excess of ether.

The solution and the ether form an emulsion very readily; consequently, they should be shaken together rather gently, preferably with a rotary motion. If an emulsion does form, it can be broken up by bubbling a stream of washed air into it. The ether complex is diluted with one-half of its volume of water, and the ether rapidly displaced by a stream of air. Should the solution become green, the yellow color can be restored by adding a little concentrated nitric acid. Crystallization takes place readily.

For purification the product is dissolved in a mixture of 50 ml. of water and 15 ml. of concentrated hydrochloric acid and extracted again with ether. The ether is removed as before, and the yellow liquid is concentrated at 40°C. It is finally crystallized at room temperature. Care must be taken to guard against reduction by dust. A little concentrated nitric acid will reoxidize the acid and restore the yellow color.

The crystals thus formed contain about twenty-nine molecules of water of hydration. Most of this water can be removed by heating the acid at 40°C. for three or four days or drying in a desiccator. The product then contains five or six molecules of water.

Analysis²

The acid is first dried to constant weight at 40°C. The total water in this partially dehydrated material is determined by igniting a weighed sample at 460 to 480°C. for 15 minutes. Care must be taken not to heat the sample above 500°C., at which temperature molybdenum trioxide volatilizes.

The molybdenum trioxide in the anhydrous material is volatilized in a stream of dry hydrogen chloride. The residue is weighed as impure silica. The silica is then determined by the loss in weight when volatilized with hydrofluoric and sulfuric acids. The molybdenum trioxide is calculated by difference.

COMPOSITION OF AIR-DRIED (4 DAYS) CRYSTALS

Found			Theory for $H_4SiMo_{12}O_{40} \cdot 6H_2O$
H_2O	7.49%	7.51%	7.45%
SiO_2	3.13%	3.13%	3.11%
MoO_3	89.40%	89.36%	89.44%
$SiO_2 : MoO_3$	1:11.93	1:11.92	1:12

Titration of the acid using methyl orange as the indicator gives an equivalent weight of 485.

References

- ILLINGSWORTH and KEGGIN: *J. Chem. Soc.*, 575 (1935).
 - HANEY: Thesis, University of North Dakota, 1933.
- For a complete bibliography consult MELLOR: "A Comprehensive Treatise on Inorganic and Theoretical Chemistry," Longmans, Green & Company, New York, Vol. VI, p. 890.

48. SILICOTUNGSTIC ACID

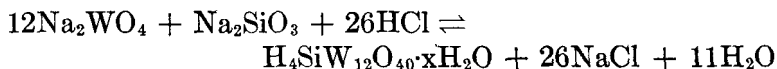

SUBMITTED BY E. O. NORTH*

CHECKED BY JOHN C. BAILAR, JR.,† AND FRANK G. JONELIS†

Silicotungstic acid is prepared by the hydrolysis of a mixture of sodium tungstate and sodium silicate. This reaction goes to completion only in the presence of acid. Sulfuric, acetic, and nitric acids all have been used,^{1,2,3} but none of them is completely satisfactory. Sulfuric acid, since it cannot be volatilized from the silicotungstic acid, is apt to cause decomposition. It also tends to precipitate

* University of North Dakota, Grand Forks, N. D.

† University of Illinois, Urbana, Ill.

tungstic acid. Acetic acid acts as a reducing agent, and nitric acid produces an undesirable increase in the density of the solution.

In this preparation, hydrochloric acid is used because it can be expelled readily from the partially dehydrated crystals by heating.

When silicotungstic acid is titrated with a base using methyl orange or chlorophenol red as the indicator, an end point is obtained when four equivalents have been added. The end point with chlorophenol is sharper because this indicator does not form a precipitate with the acid.⁴ When the acid is titrated using phenolphthalein as the indicator, the end point is not permanent. However, when the titration is carried out in a hot solution, an end point is reached when twenty-four equivalents of base have been added. The end products are sodium tungstate and silicic acid.

The salts formed with tertiary organic bases represent the neutralization of four hydrogens. Hence by some the acid is considered to be tetrabasic, whereas others consider it to be octobasic.⁵ Perhaps it is best to consider the tetra-substituted salt the normal one; and the octo-, a basic salt.

Recent X-ray data indicate that the crystalline acid contains 5 molecules of water of hydration.⁶ Earlier investigations gave values varying from 4 to 31 molecules. The concentration of a solution can be determined by titration or by evaporation followed by ignition to the anhydride.

Procedure⁷

One thousand grams of hydrated sodium tungstate is dissolved in 2000 ml. of water. To this solution is added 75 g. of a solution of water glass (density 1.375). The mixture is stirred briskly with a motor stirrer and heated to boiling while 600 ml. of hydrochloric acid (density 1.18) is added a drop at a time from a separatory funnel. This operation takes about 90 minutes. The slight precipitate of silicic acid is filtered off, and the mixture cooled. Four hundred ml. more of the concentrated hydrochloric acid is added, and the solution cooled again. This solution

is shaken with a slight excess of ether,* and the bottom oily layer of the ether complex is drawn off. This complex is dissolved in 1 l. of 3N hydrochloric acid and extracted again with a slight excess of ether which has been washed with a dilute sodium hydroxide solution.⁴ The ether complex is drawn off into a suction flask, and the ether rapidly removed by drawing washed air through the mixture while it is heated on a water bath. This is continued until crystals appear on the edge of the liquid. The solution is then set aside for slow crystallization or evaporated to dryness. The complex is again dissolved in water and taken to dryness. This procedure is repeated until the product no longer smells of the volatile acid. When sufficiently dry, the acid is ground in a mortar and dried to constant weight at 70°C.

This product has about seven molecules of water of hydration. It is very stable and is not deliquescent.

Analysis⁷

The percentage of water is determined by igniting a sample at 500°C. to constant weight.

The separation of the tungstic oxide and silica in the anhydride is effected by the method of Perillon⁸ wherein the tungstic oxide is volatilized in a current of gaseous hydrogen chloride. The silica is then volatilized by means of hydrofluoric and sulfuric acids. Since WO_3 cannot be collected readily, its weight is determined by difference.

Found		Calculated for $\text{H}_4\text{SiW}_{12}\text{O}_{40}\cdot 7\text{H}_2\text{O}$
H_2O	5.49 % 5.55 %	5.39 %
SiO_2	2.04 % 2.05 %	2.00 %
WO_3	92.46 % 92.37 %	92.61 %
	$\text{SiO}_2:\text{WO}_3::1:11.76$	1:12

References

1. MARIIGNAC: *Ann. chim. phys.*, [3] **69**, 5 (1863).
2. WYROUBOFF: *Bull. soc. franç. minéral.*, **19**, 219 (1896).

* Ethyl acetate may be used but is not so satisfactory as ether because it is not so readily volatilized.

3. COPAUX: *Bull. soc. chim.*, [4], **3**, 101 (1908).
4. SCROGGIE: *J. Am. Chem. Soc.*, **51**, 1057 (1929).
5. PAULING: *J. Am. Chem. Soc.*, **51**, 2868 (1929).
6. ILLINGSWORTH and KEGGIN: *J. Chem. Soc.*, 575 (1935).
7. NORTH and BEAL: *J. Am. Pharm. Assoc.*, **13**, 889 (1924).
8. PERILLON: *Bull. soc. ind. min.*, (1884); TREADWELL-HALL: "Analytical Chemistry," Vol. II, 7th ed., p. 277, John Wiley & Sons, Inc., New York (1928).

For a comprehensive bibliography on the heteropoly acids, consult MELLOR: "A Comprehensive Treatise on Inorganic and Theoretical Chemistry," Vol. VI, p. 890. Longmans, Green & Company, New York.

49. PHOSPHOTUNGSTIC ACID

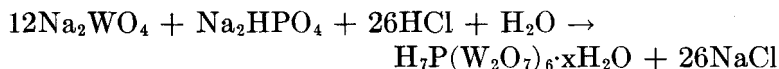

SUBMITTED BY JOHN C. BAILAR, JR.*

CHECKED BY H. S. BOOTH† AND M. GRENNERT†

Of the many phosphotungstic acids, the so-called 12-phosphotungstic acid is the most common and important. According to the Rosenheim-Miolati theory, this acid is heptabasic, and the heptaguanidine salt has been reported.³ Pauling¹ and others have criticized their theory, however, and have suggested other formulae. The large amount of water contained in the acid is evidently partly water of constitution and partly water of hydration.

Phosphotungstic acid finds use in the precipitation of proteins, alkaloids, and certain amino acids. The solubility of sodium phosphotungstate, contrasted with the comparative insolubility of the potassium and ammonium salts, has suggested its use as a reagent in qualitative analysis.

Procedure

Phosphotungstic acid is readily prepared by an adaptation of the method of Rosenheim and Jaenicke.² A kilogram of sodium tungstate ($\text{Na}_2\text{WO}_4 \cdot 2\text{H}_2\text{O}$) and 160 g. of disodium phosphate ($\text{Na}_2\text{HPO}_4 \cdot 2\text{H}_2\text{O}$) are dissolved in 1500 ml. of boiling water. Eight hundred milliliters of

* University of Illinois, Urbana, Ill.

† Western Reserve University, Cleveland, Ohio.

concentrated hydrochloric acid is added dropwise with constant stirring. Phosphotungstic acid begins to separate when about half of the acid is added. Since the precipitated acid must be purified, it is not necessary to filter it out. When the solution has cooled, ether, free from reducing impurities, is added until, after shaking, three layers remain. This requires about 600 ml. of ether. More water may be added to dissolve the sodium chloride, if necessary. The acid-ether complex, which constitutes the lower layer, is washed several times with water to which enough ether is added to form a third layer. It is then evaporated to crystallization by aspirating washed dust-free air through it.* After filtering, the crystals are allowed to stand in the open air protected from dust until they no longer smell of ether. The yield is about 80 per cent, based on the sodium tungstate.

Properties

Phosphotungstic acid crystallizes from water (in which it is extremely soluble) in very heavy white octahedra. The water solution is not stable toward light but slowly turns blue as a result of reduction. Re-oxidation is easily effected by heating with chlorine water. In spite of its great solubility in water, the acid may be completely extracted from water solution by ether. It forms with ether a dense liquid layer of a complex compound which is insoluble both in ether and in water, so that three liquid layers are formed when the water solution is extracted with an excess of ether. In addition to being very soluble in water and ether, phosphotungstic acid is readily soluble in the lower alcohols and esters.

References

1. PAULING: *J. Am. Chem. Soc.*, **51**, 2868 (1929).
2. ROSENHEIM and JAENICKE: *Zeit. anorg. allgem. Chem.*, **101**, 251 (1917).
3. ROSENHEIM and JAENICKE: *ibid.*, p. 255.

* Evaporation by heating causes reduction of the phosphotungstic acid. All dust and organic reducing vapors must be removed from the air, or reduction to the blue compound will result.

CHAPTER VII

50. ANHYDROUS HYDROGEN FLUORIDE



SUBMITTED BY J. H. SIMONS*

CHECKED BY JOEL HILDEBRAND†

Pure anhydrous hydrogen fluoride may be prepared in the laboratory by heating either anhydrous sodium hydrogen fluoride or potassium hydrogen fluoride. The latter is to be recommended, since it can be made perfectly dry by electrolysis, whereas the former gives up the hydrogen fluoride before it melts at atmospheric pressure. It is quite improbable that normal desiccation will completely dry the salt, for Fredenhagen and Cadenbach¹ have shown that the last traces of water are given off with the hydrogen fluoride only after the salt has been heated to above 500°C. A method of dehydrating the salt by electrolysis has been described by Simons.² This process not only removes the water completely but also eliminates other substances such as chlorides and fluosilicates. Hydrogen fluoride prepared from calcium fluoride and sulfuric acid contains both water and sulfur compounds as impurities.

Procedure

A design for a still suitable for this preparation is shown in Fig. 24. The vessel is made of copper, nickel, or monel metal. The copper exit tube *A* is silver soldered or brazed to the cover *D*. At the cover, it should be 1 to 2 cm. in diameter. Ten to twenty centimeters above the cover, it may be constricted to about 5 mm. At some distance from the cover, it may have a chamber containing a mass of fine copper wire to remove salt spray. However, this is

* Pennsylvania State College, State College, Pa.

† University of California, Berkeley, Calif.

not necessary, if the exit tube is at least 2 m. in length. The iron clamp *C* holds the cover on to the vessel by means of the screw *B*. The corrugated copper gasket *E* serves as the seal between the cover and the vessel.

The vessel is filled about half full of anhydrous potassium hydrogen fluoride, the preparation of which is described in connection with the high-temperature method of preparing fluorine (synthesis 51A). This is melted and kept at about 220°C. with a gas flame. The temperature may be taken with a copper-incaised thermometer. A graphite electrode, inserted into the liquid, serves as the positive pole, and the vessel as the negative electrode. The melt is electrolyzed using a current of about 5 amp., and electrolysis should be continued until fluorine has been generated in quantity for perhaps an hour. The cover of the still is now fastened securely. It has been previously cleaned and dried, and the tube filled with dry air. The vessel is now heated strongly with the ring burner *F*. A temperature of 500 to 600°C. is necessary for rapid evolution of gas. The vessel should not be heated from the bottom during the distillation, as the salt is apt to foam and clog the exit.

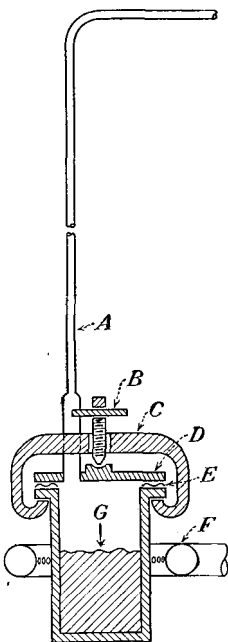

FIG. 24.—Still for generation of anhydrous hydrogen fluoride.

Should a liquid product be desired, a condenser jacket can be placed around the end of the exit tube, or the gas can be condensed directly in the apparatus in which the liquid is to be used. In any case, the receiver or reaction vessel should be tightly connected to the exit from the still.

Properties

The anhydrous hydrogen fluoride prepared in this manner is of very high purity. Its properties have been

reviewed by Simons.³ The freezing point² is $-83^{\circ}\text{C}.$; boiling point, $19.5^{\circ}\text{C}.$; density⁴ at $0^{\circ}\text{C}.$, 1 g. per milliliter; surface tension,⁴ 10.2 dynes per centimeter at $0^{\circ}\text{C}.$; and heat of vaporization,⁵ about 95 cal. per gram at the boiling point.

References

1. FREDENHAGEN and CADENBACH: *Z. anorg. allgem. Chem.*, **178**, 289 (1929).
2. SIMONS: *J. Am. Chem. Soc.*, **46**, 2179 (1924).
3. SIMONS: *Chem. Rev.*, **8**, 213 (1931).
4. SIMONS and BOUKNIGHT: *J. Am. Chem. Soc.*, **54**, 129 (1932).
5. SIMONS and BOUKNIGHT: *ibid.*, **55**, 1458 (1933).

51. FLUORINE

All methods that have been used successfully for producing fluorine in quantity are electrochemical and make use of the system hydrogen fluoride-potassium fluoride in different forms of cells and at various temperatures. Cady¹ has shown by a study of the freezing points and vapor pressures of this system that there are three regions where electrolysis to produce fluorine is practicable. In each of these regions, the system is liquid, and the vapor pressure of hydrogen fluoride is below atmospheric pressure.

At low temperature, the electrolyte consists essentially of anhydrous hydrogen fluoride made conducting with dissolved potassium fluoride. Moissan² first prepared fluorine by the electrolysis of such a solution in the low-temperature range using platinum electrodes. At about $70^{\circ}\text{C}.$, the system has approximately the composition $\text{KF}\cdot 3\text{HF}$. The electrolysis of this melt was first described by Lebeau and Damiens³ who employed nickel electrodes.

The high-temperature region begins at about $220^{\circ}\text{C}.$ where the composition is approximately $\text{KF}\cdot\text{HF}$. Argo, Mathers, Humiston, and Anderson⁴ described the first cell using a melt of this composition. Both the technique of the method and the design of the apparatus were subsequently improved by Simons.⁵

The low-temperature method requires the use of anhydrous hydrogen fluoride, which is both difficult and dan-

gerous to handle. In the presence of fluorine, it is an extremely corrosive substance and reacts with most metals. Moissan experienced considerable corrosion of his platinum electrodes. The liquid wets graphite and is reputed to disintegrate electrodes of this material. An additional disadvantage of this method is the necessity for maintenance of a low temperature.

The moderate-temperature cell has advantages where its use is required continuously, where anhydrous hydrogen fluoride is available, where fluorine free from all traces of carbon fluorides is required, and where it is operated by experienced and competent workers. Its advantages are that only a moderate temperature is used and the regeneration of the electrolyte is simplified in that large quantities of water need not be removed.

For ordinary laboratory purposes and for intermittent use, the high-temperature cell seems to have some advantages. It is the least expensive to build and does not require the use of anhydrous hydrogen fluoride in the preparation or regeneration of the electrolyte. As the fresh electrolyte does not readily absorb water, the cell may be left exposed to the ordinary laboratory air for days and still generate fluorine almost immediately when put into operation. Its use is attended by little danger, and it requires only a small amount of auxiliary apparatus. The fluorine contains as an impurity small amounts of carbon fluorides from the reaction with the graphite anode.

Directions for the preparation of fluorine both by the high-temperature (A) and by the medium-temperature (B) methods follow. Because of the peculiar properties of fluorine and the danger attending its preparation and use it is suggested that anyone who plans to work with the gas read the very interesting paper by Lebeau.⁶ A comprehensive review of the literature up to 1927 is to be found in it.

A. FLUORINE BY THE HIGH-TEMPERATURE METHOD

SUBMITTED BY J. H. SIMONS*

CHECKED BY W. C. JOHNSON†

Apparatus

A design of a fluorine generator which is both economical to build and convenient to operate is shown in Fig. 25. The total cost of the material including a supply of the electrodes is about \$10. About 2 kg. of electrolyte is required for one charge, and the cell will operate on this quantity for 25 to 50 hours while carrying a current of 10 amp.

The simplicity of this cell gives it advantages over more complicated designs. The special features that facilitate its operation are as follows:

1. The copper plate over the top of the heating element protects the latter from the electrolyte. By exposing no material containing silica to possible contact with the electrolyte, it eliminates this source of contamination.

2. The open anode side of the cell allows free escape of the hydrogen and permits easy observation of the electrolyte. This reduces the danger of the explosions, should the fluorine stream become stopped in the apparatus in which it is used, and allows possible escape through the anode chamber. Difficulties cannot be encountered in a stoppage of the escape of the hydrogen.

3. The large size of the fluorine exit tube and its angle with the horizontal eliminate clogging with solidified electrolyte. Occasional warming with a gas flame will melt out any electrolyte carried into it as spray.

4. The Portland cement seal for the cathode is the easiest insulating seal to make and is entirely satisfactory, as it develops a porcelain-like consistency after the cell has been used a short time. It adheres firmly to both the graphite electrode and the copper-seal tube. The detail construc-

* Pennsylvania State College, State College, Pa.

† University of Chicago, Chicago, Ill.

tion of the top of the diaphragm, as shown, permits this seal to be made with ease. A small thin paper washer is

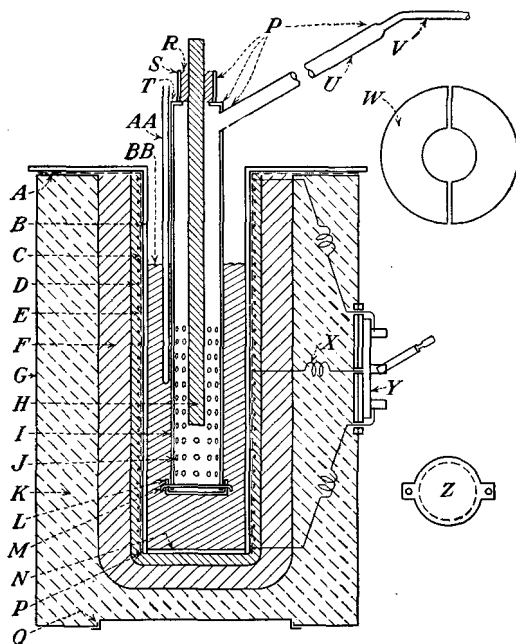

A, copper plate $\frac{1}{8}$ in. thick of sufficient size to overlap the furnace. It is securely silver soldered to the well. The negative lead from the direct-current source is connected to this plate by means of a battery clip; B, well, made of copper tubing 12 in. long, 3 in. i. d., and a wall thickness of $\frac{1}{8}$ in.; C, asbestos paper wrapping; D, nichrome wire heating element, 50 ft. of No. 18; E, aluminum cement coating about $\frac{1}{4}$ in. thick; F, coating of a mixture of fire clay and sand about 1 in. thick. This gives rigidity and permanence to the heating unit and is inexpensive; G, sheet-metal can, usual type of container for chemicals; H, electrode, graphite rod 12 in. long and $\frac{1}{2}$ in. in diameter, made of a special mix with a minimum of silicon binder. The positive lead from the direct-current source is connected to the top of this electrode by means of a battery clip; I, diaphragm, made of copper tubing 12 in. long, $1\frac{3}{4}$ in. in diameter, and with a wall thickness $\frac{1}{16}$ in.; J, holes drilled in diaphragm, $\frac{1}{8}$ in. in diameter; K, magnesia or asbestos refractory packing; L, bottom of diaphragm, made of $\frac{1}{16}$ -in. copper sheet; M, copper wire for connecting bottom to diaphragm; N, bottom of well, made of $\frac{1}{8}$ -in. copper sheet; P, joints made with hard-silver solder; Q, press lid of well, made of $\frac{1}{8}$ -in. copper sheet; R, Portland cement seal; S, seal tube, made of copper tubing $1\frac{1}{4}$ in. long, 1 in. in diameter, and $\frac{1}{16}$ -in. wall size. It is convenient to support the diaphragm by means of a clamp on this tube; T, copper disk with $\frac{3}{4}$ -in. center hole; U, fluorine exit tube, $\frac{1}{2}$ in. in diameter and 12 in. long; V, copper tube $\frac{1}{4}$ in. in diameter. W, cover for cell, when not in use, made of $\frac{1}{16}$ -in. copper plate in two parts with center hole large enough to fit around diaphragm; X, center lead from heating element; Y, double-throw double-pole switch, so connected as to enable the two halves of the heating element to be placed in either parallel or series. The series connection is for the regular operation of the cell; the parallel, for rapidly raising the temperature. Transite boards inside and outside the metal can form the base upon which the switch is fastened; Z, detail construction of bottom of diaphragm; AA, thermometer well, a copper tube sealed at the bottom. It is convenient to have this only temporarily fastened to diaphragm with copper wire or better supported from a ring stand. A thermocouple is more convenient to use than a mercury thermometer. If the latter is used, it should be covered with a film of heavy oil; BB, electrolyte.

FIG. 25.—High-temperature fluorine generator.

cut to fit cathode and seal tube and placed at the bottom of the latter. With the electrode securely held and cen-

tered, the cement, made into a thick cream with water, is poured in. The paper washer prevents it from running into the cathode chamber, and in operation the fluorine soon removes the paper. It is of advantage to have the electrode extend through the seal rather than to make connection with it inside the cathode chamber. To replace the electrode it can be broken out of the seal without injuring the latter. The hole is enlarged slightly by filing; and the new electrode, after being coated with fresh wet cement, is put into place.

5. The bottom of the diaphragm is a variation of the bayonet joint. It may be removed from the diaphragm but cannot come off in operation, as sometimes happens with the bayonet type of bottom.

The Electrolyte

The electrolyte is prepared more cheaply from potassium fluoride and aqueous hydrogen fluoride than from potassium hydrogen fluoride. Pure chemicals must be used, as the technical grades contain impurities which cause undue polarization of the cell. A slight excess of the acid is added to the salt in a large copper container, the temperature slowly raised to the boiling point, and most of the water evaporated. If the temperature is raised quite slowly, the salt will be taken into solution without any considerable loss of hydrogen fluoride. When most of the water has been removed, the temperature will begin to rise rapidly.

A bundle of graphite electrodes, fastened so that there is space between them, is now placed in the liquid. A current of 5 to 10 amp. is passed through the melt, with the graphite rods comprising the anode and the copper vessel acting as the cathode. When the temperature reaches about 210°C. and fluorine begins to form at the anode, the electrolyte is ready to pour into the cell. The fluorine can be detected by its odor, the crackling noise made by its union with the hydrogen, and its ability to ignite illuminat-

ing gas. The same procedure as that given above is used for regenerating the electrolyte.

Operation of the Cell

The normal voltage of the cell, either in operation or when removing the water in the preparation of the electrolyte, is 10 to 20 volts. If the cell polarizes, this rises to 50 or more volts, with a corresponding reduction in amperage. A luminous discharge will at the same time appear at the graphite electrode. This polarization should not be allowed to continue as it disintegrates the electrode. It can be stopped by momentarily reversing the current. Reducing the current density reduces the tendency to polarize. The amount of polarization is dependent on the amount of impurities in the electrolyte. If pure chemicals are used, and the foregoing technique followed, the polarization period is quite short, not more than an hour at the longest. As all interfering impurities are removed during the preparation and use of the electrolyte, a regenerated electrolyte is better than a fresh one. The preparation and preliminary electrolysis of the electrolyte outside the cell protect the electrode of the latter from the corrosion caused by polarization.

As hydrogen fluoride is removed from the electrolyte, potassium fluoride is precipitated in the bottom of the cell, the bath becomes viscous, and the temperature necessary to keep it molten rises. When a temperature of 280 to 300°C. becomes necessary, the loss of hydrogen fluoride by evaporation is excessive; and the electrolyte should be regenerated. It can be ladled out of the cell into a cold copper dish and broken into small pieces when solidified.

Copper is by far the cheapest and most convenient material for use in making such a cell. Other metals such as magnesium, nickel, and monel metal have been used. Although there is some corrosion of the vessel and diaphragm, and some copper fluoride is formed in the electrolyte, this does no harm, but if, after a number of regen-

erations of the electrolyte, it becomes excessive, it can be removed by pouring the freshly prepared electrolyte, while molten, through copper gauze.

Cell Efficiency

The efficiency of fluorine production has been found to be about 80 per cent, with a variation of ± 5 per cent depending on the age of the electrolyte, its condition, etc. No general variation of efficiency with amperage was observed except a decrease with currents over 10 amp. Cell efficiencies were determined by conducting the fluorine into a stream of hydrogen, absorbing the hydrogen fluoride produced in tubes of sodium fluoride, and weighing. An electrical discharge at the junction of the fluorine and hydrogen streams served to effect smooth and continuous combination. Hydrogen fluoride was removed from the fluorine before it entered the hydrogen stream. The following table gives examples of individual efficiency determinations:

Temp. of cell, °C.	267	280	278	268	260	259	267
Amp.	9.85	14.2	11.4	7.2	2.4	5.05	8.65
Volts.....	14	16	16	16	13	15.5	17
Efficiency.....	85	73	76	80	78	77	80

B. FLUORINE BY THE MEDIUM-TEMPERATURE METHOD

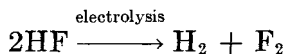

SUBMITTED BY GEORGE H. CADY*

CHECKED BY A. L. HENNE†

The following procedure yields fluorine free from the usual impurities of the fluorides of carbon and silicon and operates at the convenient temperature of 75°C.

This method is similar to that of Lebeau and Damiens,^{3,6} differing only in details, such as the use of commercial

* University of Washington, Seattle, Wash.

† The Ohio State University, Columbus, Ohio.

anhydrous hydrofluoric acid and the establishment of an upper concentration limit of 43.4 per cent HF.

Procedure

The electrolyte, which will be discussed in detail later, is contained in a cylindrical pot which serves as the cell (see Fig. 26). This vessel is made from $\frac{1}{8}$ -in. monel metal sheet and has a depth of 14 in. and an inside diameter of 4 in. In place of monel metal, other materials may be substituted, the most economical being steel. Supported within the pot by a lid of sheet copper is a diaphragm in which fluorine collects. It is made from 2-in. copper tubing, is insulated from the lid by Portland cement, and has near its base three openings about $1\frac{1}{2}$ in. square.

The section of $\frac{1}{4}$ -in. tubing which runs through the insulator acts both as an electrical connection to the anode and as an exit for the fluorine. A piece of 0.0032-in. sheet nickel $3\frac{1}{2}$ in. square rolled into a cylinder serves as an electrode, and it is bolted to the center of a disc of copper which covers the bottom of, and is firmly fastened to, the diaphragm. With such a combination, fluorine is liberated on the nickel but not on the copper. A thermometer well of copper tubing is fastened to the cover of the pot.

A satisfactory electrolyte is made from anhydrous hydrofluoric acid and a technical grade of potassium acid fluoride. The use of a pure dry salt has only minor advantages, because electrolysis soon removes water and undesirable impurities. After melting 2 kg. of potassium bifluoride in

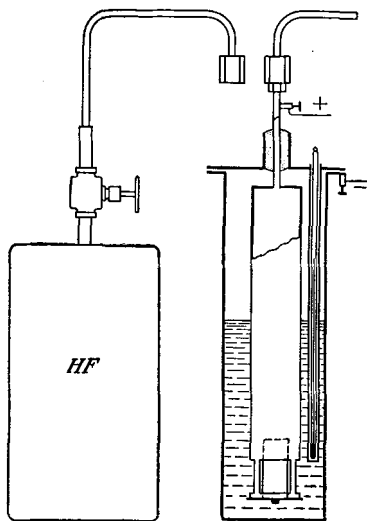

FIG. 26.—Cell for medium-temperature generation of fluorine.

the pot, a direct current of 12 to 15 amp. is passed through the solution until fluorine is liberated. For this purpose, a 1-in. graphite rod is used as the anode, and the process does not require much over 3 hours. During this period, the temperature of the liquid is kept below 250°C., and arcing at the electrode, which occurs frequently, is stopped by temporarily opening the circuit.

The next step in the procedure consists of the addition of hydrogen fluoride to the molten salt. To accomplish this, hydrogen fluoride is distilled at a moderate rate from a cylinder* into the molten potassium bifluoride until the liquid contains about 43.4 per cent hydrogen fluoride. This corresponds to a mol fraction of hydrogen fluoride of 0.69. Since the absorption of hydrogen fluoride liberates considerable heat, a large part of the acid will be lost, unless the rate of addition is controlled so that the temperature of the solution remains near its melting point. This has been decreased to about 72°C. when enough hydrogen fluoride has been added to raise its mol fraction to 0.66.

With the diaphragm in position, electrolysis is carried out using the monel-metal pot as the cathode. If the potassium bifluoride has been well purified, fluorine will be produced at the nickel electrode soon after the current starts to flow. If the source of electricity is a 110-volt direct-current line, a simple rheostat to allow the control of the current may be made from one 500- and two 1000-watt electric heater units.

The temperature of the electrolyte may be allowed to rise to about 150°C., but such a practice is undesirable, because a considerable quantity of hydrogen fluoride is lost by evaporation and because the nickel electrode is corroded more rapidly at this higher temperature. The most satisfactory range is between 73 and 75°C. Unless some means is adopted to remove the excess heat, a current greater than 8 amperes causes the cell to become too warm. A blast

* Obtainable from The Harshaw Chemical Company, Cleveland, Ohio.

of air from an electric fan directed against the lower part of the monel pot helps considerably.

To minimize the number and violence of the explosions that sometimes occur in the gas chamber above the cathode, the lid for the pot should be made to fit only very loosely. If a $\frac{1}{8}$ -in. gap is allowed, no explosions of any consequence take place. When the cell is not in use, this gap should be closed.

No harm is done when the electrolyte is allowed to solidify in the generator; but when it is again melted, the burners should be allowed to melt the top part of the solid before the bottom is heated. Repeated violation of this precaution might rupture the apparatus, because the density of the solid is greater than that of the liquid. A circular gas burner which directs flames inwardly may be adjusted to heat the cell in the desired manner. No heating is necessary while electrolysis is in progress, unless a small current is used.

After the generator has been used a number of hours, one observes that the electrolyte does not become completely molten, even though the temperature is maintained at 75° or above for some time. The solid is potassium bifluoride and its appearance indicates that hydrogen fluoride should be bubbled into the solution until it again contains about 43.4 per cent hydrogen fluoride. The diaphragm itself makes a good bubbler.

With a current of 12 amp. this apparatus has a current efficiency between 60 and 84 per cent, the average being about 72 per cent. The inefficiency is due in part to corrosion of the nickel and probably in part to bubbles of fluorine rising in the cathode chamber rather than in the diaphragm. Improvement in the design of the diaphragm openings might increase the efficiency. The volume of gas produced may be measured by collecting it in a vessel of known capacity to which a manometer is attached so that pressures may be determined.

Fluorine prepared in this way is relatively pure. After hydrogen fluoride vapor has been removed by sodium fluoride, one finds that of a sample of the gas in a glass bulb, about 98 per cent is absorbed by mercury. Probably the fluorine is more nearly pure than this would indicate.

Hydrogen fluoride may be removed from fluorine by absorption over dry potassium fluoride or sodium fluoride or by passing the gas through a trap cooled with liquid oxygen. Probably the latter method is most effective. If one of the salts is used, it is necessary that it should be pure and dry. Moisture introduces oxygen into the fluorine, whereas chlorides will lead to contamination of the fluorine with chlorine.

Apparatus in which fluorine is to be handled at room temperature may be made from a number of metals. Platinum, copper, nickel, magnesium, monel metal, brass, steel, and German silver are all known to be satisfactory. Most of these become coated with a film of fluoride which prevents further corrosion. If the metal is in contact not only with fluorine but also with a liquid such as water or hydrogen fluoride, corrosion frequently becomes troublesome. Under such circumstances, platinum usually behaves in the most satisfactory manner. With the gas alone, brass needle valves may be used with success, but the packing is eventually ruined. Fabrication of apparatus is best accomplished by welding, brazing, or silver soldering. Solder made from lead and tin does not resist attack.

The author has used equipment of this type for research purposes through a period of 18 months for about 250 hours. At no time, however, was the cell required to operate more than a few hours without stopping electrolysis. The only type of repair that became necessary at rather regular intervals was the replacement of the nickel anode.

References

1. CADY: *J. Am. Chem. Soc.*, **56**, 1431 (1934).
2. MOISSAN: *Compt. rend.*, **102**, 1543 (1886); **103**, 202, 256 (1886).
3. LEBEAU and DAMIENS: *Compt. rend.*, **181**, 917 (1925).

4. ARGO, MATHERS, HUMISTON, and ANDERSON: *Trans. Am. Electrochem. Soc.*, **35**, 335 (1919); *J. Phys. Chem.*, **23**, 348 (1919).
5. SIMONS: *J. Am. Chem. Soc.*, **46**, 2175 (1924).
6. LEBEAU: *Bull. soc. encour. ind. nat.*, **139**, 15 (1927).

52. HYDROGEN CHLORIDE

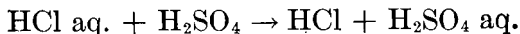

SUBMITTED BY R. N. MAXSON*

CHECKED BY H. S. BOOTH† AND S. J. REHMAR†

Gaseous hydrogen chloride is usually prepared in the laboratory by the reaction of concentrated sulfuric acid on sodium chloride or upon concentrated hydrochloric acid. The following directions for the latter method are taken from a note by O. R. Sweeney¹ and are very satisfactory.

Procedure

Fit a 1 l. separatory funnel (cylindrical, Fig. 27, or conical type, Fig. 28) as shown in the diagrams. *A*, a small dropping funnel sealed to a capillary tube about 40 cm. in length, is fitted into the separatory funnel. It is important that this tube be capillary so that it will fill with acid and thus give the hydrostatic pressure necessary to force the hydrochloric into the sulfuric acid. The capillary tube also insures a readily controlled and uniform flow of gas.

To operate the generator, place a convenient volume (say 200 ml.) of concentrated sulfuric acid in the large separatory funnel, raise the small funnel until the capillary is above the sulfuric acid, fill the capillary with concentrated hydrochloric acid, replace the stopper, and adjust the flow of gas by regulation of the hydrochloric acid supply. The apparatus, even when producing a rapid stream, does not heat up to any extent. Furthermore, the danger of sulfuric acid spray being carried over is not great. After using a volume of hydrochloric acid equal to that of the sulfuric (yield 32.7 g. HCl per 100 ml. hydrochloric acid)

* University of Kentucky, Lexington, Ky.

† Western Reserve University, Cleveland, Ohio.

discontinue the generation, drain out the diluted sulfuric acid, and recharge. If more than an equal volume of hydrochloric acid is used, the gas is obtained in decreased yields and continues to be formed for a time after the stop-

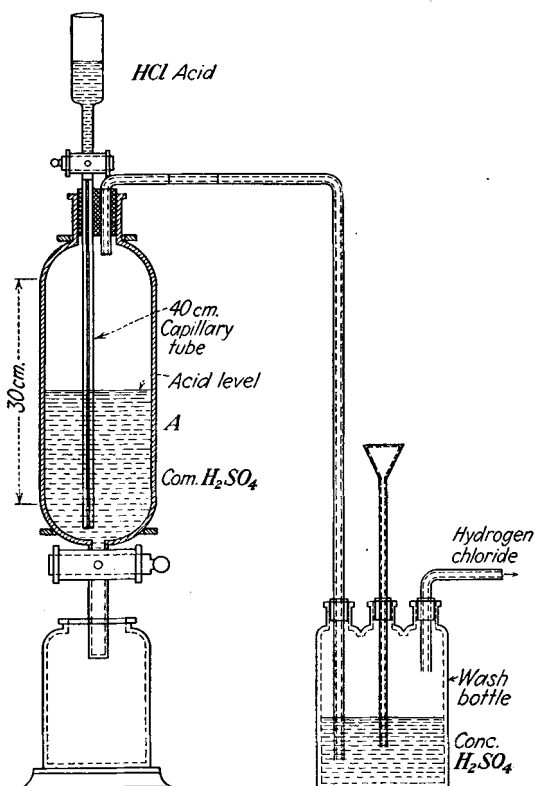

FIG. 27.—Cylindrical separatory funnel, hydrogen chloride generator.

cock is closed. Because of the action of hydrogen chloride upon rubber, very accurate work would require that the rubber stopper be replaced by a glass joint. The spent acid is only diluted, does not contain much hydrogen chloride, and can be used for other purposes in the laboratory.

Using the apparatus shown in Fig. 28, the checkers obtained a yield of 80 per cent HCl gas using 75 ml. conc. sulfuric acid and 40 ml. conc. hydrochloric acid.

Properties

Pure hydrogen chloride is a colorless gas condensing to a white solid melting at -111°C . to a colorless liquid boiling at -85°C .

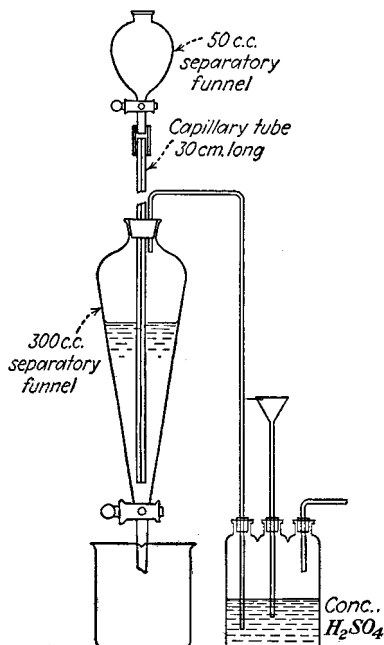

FIG. 28.—Conical separatory funnel, hydrogen chloride generator.

Reference

1. SWEENEY: *J. Am. Chem. Soc.*, **39**, 2186 (1917).

53. HYDROGEN BROMIDE

The choice of a method for the preparation of hydrogen bromide will be governed largely by two factors: first, the quantity desired and, second, the use to be made of the material, *i.e.*, whether the anhydrous gas or the aqueous solution is desired. Any method for the production of hydrogen bromide gas may be adapted to produce a solution of hydrobromic acid. On the other hand, it is entirely

impractical to attempt to obtain the anhydrous gas from its aqueous solution.

Hydrogen Bromide Gas. Hydrogen bromide cannot be prepared satisfactorily by the method commonly employed for the preparation of hydrogen chloride, *i.e.*, by the action of concentrated sulfuric acid on a metallic halide, since the hydrogen bromide that is formed is largely oxidized by the sulfuric acid to give bromine and sulfur dioxide. This reaction, however, may be adapted to produce constant-boiling hydrobromic acid by suitable control of conditions (procedure C). The oxidation of hydrogen bromide may be avoided by using phosphoric in place of sulfuric acid, but this reaction is very slow, and external heat must be applied. The product, moreover, contains appreciable quantities of water vapor.

The common method involves the action of bromine upon a mixture of red phosphorus and water.¹⁻³ The reaction is apt to be violent, and the mixture has been known to explode. The hydrogen bromide is freed from bromine by passing the gas over damp red phosphorus. It is difficult to maintain a steady stream of gas. The product requires drying and is usually contaminated with traces of volatile phosphorus compounds and with small quantities of various arsenic compounds which are derived from impurities in the phosphorus.

Methods based on the evolution of hydrogen bromide during the bromination of an organic compound have been proposed by a number of workers. Many organic compounds are too volatile and consequently lead to contamination of the product with organic vapors. However, in procedure A, tetrahydronaphthalene*⁴ is used on account

* Tetrahydronaphthalene is readily available, being used commercially under various trade names (Tetralin, Tetranap, etc.) as a solvent and as a paint and varnish thinner. The presence of decahydronaphthalene or of small quantities of naphthalene does not lead to any contamination of the hydrogen bromide. The decahydro- compound may be used in place of the tetrahydro- compound, but it is more volatile (b.193°, vapor pressure 0.8 mm. at 15°C.) and reacts more slowly.

of its low volatility (b. 207°C., vapor pressure, 0.3 mm. at 15°C.) and the non-volatility of its bromination products. It reacts steadily with bromine, and the reaction is neither violent in the early stages nor too slow subsequently. External heat is not needed and should, in fact, be avoided, as it increases the volatility of the organic compounds. The hydrogen bromide formed is pure and dry.

Although the action of bromine on tetralin readily yields hydrogen bromide, 50 per cent of the bromine is lost in its combination with the organic molecule. Where larger quantities of hydrogen bromide for production of hydrobromic acid are required, it is advisable to make use of the method of direct combination of hydrogen and bromine, using a suitable catalyst (procedure B).^{1,5,6}

Hydrobromic Acid. Hydrobromic acid may be prepared conveniently by the interaction of bromine and sulfur dioxide in the presence of water.⁷ An even simpler procedure for the preparation of constant-boiling hydrobromic acid consists of the action of sulfuric acid upon a bromide under conditions such that no oxidation takes place (procedure C)⁸ or by the bromination of a 1:1 mixture of water and tetrahydronaphthalene (procedure A, note).

A. HYDROGEN BROMIDE BY BROMINATION OF TETRAHYDRONAPHTHALENE

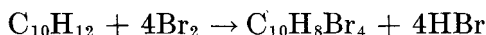

SUBMITTED BY D. R. DUNCAN*

CHECKED BY H. S. BOOTH† AND R. ROTH†

Procedure

The tetrahydronaphthalene is placed in a flask fitted with a dropping funnel and a delivery tube. Dry air should be *bubbled through the liquid* for at least 30 minutes to remove water. If water is present, the yields of gaseous hydrogen bromide will be greatly lowered. The bromine

* 50 Buckleigh Ave., London, S.W. 20, England.

† Western Reserve University, Cleveland, Ohio.

may be allowed to drop in at a steady rate, whereupon a regular stream of hydrogen bromide will be evolved. Traces of free bromine may be removed by bubbling through tetrahydronaphthalene. A 47 per cent yield of hydrogen bromide (calculated on the weight of bromine taken) corresponding to 94 per cent of the theoretical yield possible, has been obtained in practice.*

B. HYDROGEN BROMIDE (HYDROBROMIC ACID) BY DIRECT COMBINATION OVER PLATINIZED SILICA GEL

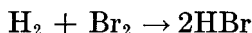

SUBMITTED BY JOHN M. SCHNEIDER† AND W. C. JOHNSON‡

CHECKED BY CHARLES SLOBUTSKY‡ AND L. F. AUDRIETH‡

Procedure

Apparatus. A pyrex tube *D*, 50 cm. in length and 4 cm. in diameter (Fig. 29), is filled with approximately 300 g. of platinized silica gel§ packed at each end with a plug of glass wool. The catalyst tube is wrapped with asbestos paper and placed in the electric furnace *E*. The tube is drawn down at each end,|| and a 200-ml. distilling flask *B*

* When the checkers observed that small amounts of water in the tetrahydronaphthalene lowered the yield of gaseous hydrogen bromide, it occurred to them that aqueous solutions of hydrobromic acid should be easily prepared by bromination of tetrahydronaphthalene in the immediate presence of relatively larger quantities of water. Accordingly, approximately equal volumes of water and tetralin were placed in a flask and agitated while the liquid bromine was added. The two components were separated by means of a separatory funnel, and the non-aqueous component was washed with water, the washings being added to the original water solution.

Analysis of the water solution in two experiments gave a yield of 93 per cent of the theoretical, corresponding to a conversion of 46.5 per cent of the bromine used to hydrobromic acid.

† University of Chicago, Chicago, Ill.

‡ University of Illinois, Urbana, Ill.

§ The Davison Chemical Co., Silica-Gel Division, Baltimore, Md.
EDITOR'S NOTE: Platinized asbestos may also be used in place of platinized silica gel.

|| It is desirable to have the exit tube inclined so that it will slope away from the bottom of the catalytic chamber and permit easy drainage of any liquid which might collect in this region.

is sealed to the entrance of the catalyst tube, and a scrubbing tower *F* is sealed to the exit. The latter is filled with glass beads coated with moist red phosphorus. The beads are held in place with plugs of glass wool. The tower is closed at both ends with rubber stoppers which are sealed in place with sealing wax.

The distilling flask is fitted with a dropping funnel *C*, the stem of which reaches well below the side arm, and an inlet tube, extending to the bottom of the flask. Rubber stoppers may be used for the flask and funnel connections,

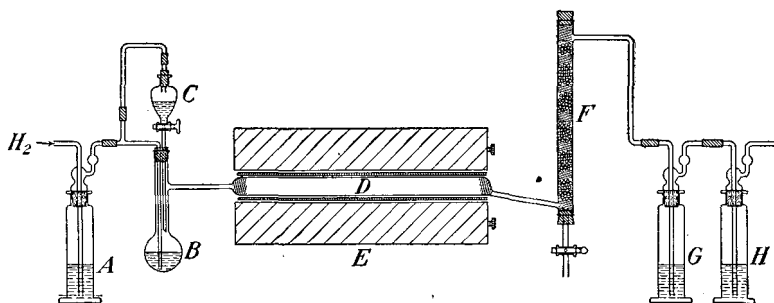

FIG. 29.—Arrangement of apparatus for catalytic synthesis of hydrogen bromide.

although they are attacked by bromine and must be replaced from time to time. For purposes of safety it is desirable to paint the flask black, if it is to be exposed to direct light; however, it is convenient to leave a narrow, unpainted strip near the bottom of the flask so that the quantity of bromine may be observed easily.

Hydrogen gas from a tank passes through a wash bottle *A* containing water, which serves as a flow indicator, and then enters the bromine flask *B*. A T tube is connected in the glass system so that part of the hydrogen stream may be diverted to the dropping funnel, thus equalizing the pressure during the addition of bromine. The hydrogen and bromine combine in the catalyst tube to form hydrogen bromide which passes through *F* and *G*.

The wash bottle *G*, which contains a few milliliters of water, absorbs any phosphorous acids and phosphorus

tribromide that may be carried along with the gas stream. Other wash bottles are connected in series at *H* to absorb the hydrogen bromide. It is essential that all of these bottles be securely fastened at the top to withstand the pressure developed by the rapid flow of gases.

If gaseous hydrogen bromide is desired, a calcium chloride drying tube or better, a calcium bromide tube, may be connected after scrubber *G*, and the gas condensed with liquid air and purified by fractional distillation.

Manipulation. In the actual operation of the apparatus, the air is first displaced by hydrogen, and then the furnace is allowed to heat gradually to 350°C. Liquid bromine is added as needed in 50-ml. portions through the dropping funnel, and the flow of hydrogen is made as rapid as the bottles will bear. For the apparatus described above, this rate will correspond closely to an outflow of excess hydrogen of 90 ml. per second, provided the temperature of the bromine is about 25°C. If the bromine flask is maintained at 30°C., with the same hydrogen flow, the amount of the exhaust hydrogen will drop to 75 ml. per second; and with the bromine at 40°C., to 60 ml. per second. It is advisable to have a large excess of hydrogen in the gas stream so that the amount of bromine carried through in the free condition is negligible.

Experiments were carried out at temperatures approaching 375°C., in which the hydrogen bromide was absorbed in water in order to determine the speed of the reaction. With the bromine at 40°C. under the conditions described above, 500 g. of bromine was found to be converted to hydrogen bromide in 50 minutes. The wash bottles containing the water for absorption of the hydrogen bromide were surrounded by an ice-salt mixture. The hydrobromic acid solution was colorless and was found to have a specific gravity of 1.78. This value corresponds to a solution containing approximately 65 per cent hydrogen bromide. In one experiment with larger quantities, 2½ kg. of bromine was converted into hydrogen bromide in 5 hours at 375°.

Cheaper grades of bromine may be used without seriously affecting the efficiency of the catalyst. When a fresh lot of catalyst is used, it should be heated in the tube for 24 hours and then repacked. The silica gel shrinks appreciably, and, if this precaution is not observed, a channel will develop above the catalyst, and the amount of uncombined bromine escaping will be too great to be removed in the scrubbing tower. With the apparatus operating properly, one filling of phosphorus is sufficient for a 12-hour run with a high-velocity gas stream.

C. CONSTANT-BOILING HYDROBROMIC ACID

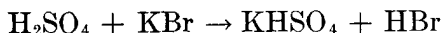

SUBMITTED BY G. B. HEISIG* AND E. AMDUR*

CHECKED BY JOHN C. BAILAR, JR.,† AND WILLIAM H. LANHAM†

Procedure

Add 120 g. of powdered potassium bromide to 200 ml. of water. Place the container in cold water, and slowly add 90 ml. of conc. sulfuric acid (1.7 mols). The temperature should not go appreciably above 75°C.; otherwise a small amount of free bromine may be formed. However, the formation of a small amount of bromine is not particularly serious, since it will come over with the distillate boiling between 100 to 115°C. Cool the solution to room temperature, and remove the potassium acid sulfate by filtering through a hardened filter paper in a Büchner funnel. Place the filtrate in a 500-ml. distilling flask connected to a water condenser fitted with an adapter, and heat over a wire gauze. If the presence of 0.01 to 0.015 per cent of sulfate ion is not objectionable, reserve the distillate that starts to come over 1° below the temperature of the constant-boiling mixture. The distillation should be stopped when the temperature drops. The specific gravity of the solu-

* University of Minnesota, Minneapolis, Minn.

† University of Illinois, Urbana, Ill.

tion will vary because of the variation of composition of the distillate with the barometric pressure. A yield of approximately 85 per cent will be obtained. The yield may be increased by redistilling the low-boiling portions.

If constant-boiling hydrobromic acid free from sulfate ion is wanted, collect the distillate over a range starting 5° below the temperature at which the constant-boiling acid distills. Redistill this acid, and reserve only the distillate coming over at the constant-boiling temperature to obtain constant-boiling acid of the highest specific gravity. The addition of barium hydroxide before the second distillation did not give a purer product. The yield is approximately 85 per cent of that calculated.

The yield of the product was considerably lowered by reducing the ratio of potassium bromide to sulfuric acid.

Properties

Hydrogen bromide is a heavy, colorless gas (m. $-86^{\circ}\text{C}.$, b. $-67^{\circ}\text{C}.$, critical temperature $+91.3^{\circ}\text{C}.$, and critical pressure probably about 68 atm.). It fumes in moist air and dissolves readily in water, 1 volume of water dissolving 600 volumes of hydrogen bromide at $0^{\circ}\text{C}.$ Hydrogen bromide behaves as a strong acid in aqueous solution; the anhydrous liquid has a very low specific conductivity (0.05×10^{-5}). Its dielectric constant is 6.29 at -80° and 2.160 at $-69^{\circ}\text{C}.$ The latent heat of fusion is 7.44, and that of vaporization 51.3 g.-cal. per gram. The refractive index of hydrogen bromide gas is 1.0006149 for $\lambda 5461\text{\AA}.$ at $0^{\circ}\text{C}.$ and 760 mm.

The saturated aqueous solution contains 68.85 per cent hydrogen bromide at 0° and 66 per cent at $25^{\circ}\text{C}.$ The boiling point of a constant-boiling mixture is 122.5° at 740 mm. and $126^{\circ}\text{C}.$ at 760 mm., and the composition is 47.38 per cent HBr at 752 mm. and 47.86 per cent at 762 mm. The specific gravity of 35 per cent hydrobromic acid is 1.315; of 40 per cent, 1.377; of 45 per cent, 1.445; and of 50 per cent, 1.517.

References

1. BILTZ, BLANCHARD, and HALL: "Laboratory Methods of Inorganic Chemistry," p. 71, John Wiley & Sons, Inc., New York, 1928.
2. BORNEMANN: "Anorganische Präparate," p. 46, Verlag von L. Voss, Leipzig, 1926.
3. VANINO: "Handbuch der präparativen Chemie," 3d ed., Vol I, p. 55, Verlag von F. Enke, Stuttgart, 1925.
4. MULLER: *Monatsh.*, **49**, 29 (1928).
5. RICHARDS and HÖNIGSCHMIDT: *J. Am. Chem. Soc.*, **32**, 1581 (1910).
6. "Organic Syntheses:" Vol. XV, p. 35, John Wiley & Sons, Inc., 1935.
7. "Organic Syntheses:" Collective Vol. I, p. 23, John Wiley & Sons, Inc., New York, 1932.
8. HEISIG and AMDUR: *J. Chem. Educ.*, **14**, 187 (1937).

54. HYDRIODIC ACID

Hydrogen iodide was first made by Courtois¹ in 1813. Gay-Lussac² showed that the union of hydrogen and iodine was achieved when the vapors were passed through a red-hot tube. In 1824, Turner³ showed that the union took place at ordinary temperature in the presence of platinum black or platinum sponge. The usual method of making hydriodic acid has long involved the action of iodine upon aqueous hydrogen sulfide.⁴ Hydrolysis of phosphorus iodide has also been used for its preparation.

Two procedures are given here: one of the hydrogen sulfide method, and the other the catalytic union of the elements followed by the absorption of the gas in water.

A. ACTION OF IODINE ON HYDROGEN SULFIDE

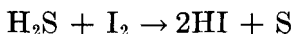

PROPOSED BY G. B. HEISIG* AND O. C. FRYKHOLM*

CHECKED BY E. R. CALEY† AND M. G. BURFORD‡

One hundred and fifty milliliters of water and 120 g. of iodine are placed in a wide-necked 500-ml. flask provided with a three-hole stopper through which pass the rod of an efficient mechanical stirrer, a hydrogen sulfide conducting

* University of Minnesota, Minneapolis, Minn.

† Princeton University, Princeton, N. J.

‡ Wesleyan University, Middletown, Conn.

tube extending well below the surface of the liquid, and an exit tube leading to a hood, a vent, or a flask containing sodium hydroxide solution. In case this last is used, care should be taken that the end of the hydrogen sulfide exit tube is placed above the surface of this solution.

After the stirrer is started, hydrogen sulfide is passed into the suspension of iodine as rapidly as it can be absorbed. The iodine need not be pulverized, but the mixture must be thoroughly and rapidly stirred to prevent the sulfur from forming a coating over the undissolved iodine. The stirrer should extend close to the bottom of the flask. The solution will become nearly colorless in about an hour.

The larger pieces of sulfur are removed by decantation or filtration through glass wool, and any finely divided sulfur by filtration through an asbestos mat in a Gooch crucible. The excess hydrogen sulfide is eliminated by boiling the filtrate until no test for hydrogen sulfide can be obtained.

The solution is again filtered, if necessary. The hydriodic acid is distilled from a 250-ml. distilling flask using porcelain chips, capillary tubes sealed at the upper end, or other suitable means to prevent bumping. The distillate boiling between 125 to 127°C. is collected.

The yield of constant-boiling acid is about 110 to 120 ml., or 90 per cent, based on the amount of iodine used. The product has a specific gravity of about 1.7 with a content of 57 per cent hydrogen iodide. If pure iodine and hydrogen sulfide are employed, the acid prepared in this way is quite pure except for a small amount of dissolved iodine produced by air oxidation. If a colorless product is desired, the distillation should be carried out in an atmosphere of hydrogen or carbon dioxide.

Hydriodic acid should be preserved in a well-stoppered dark bottle sealed with paraffin; and if care is taken to displace the air above the surface of the liquid with an inert gas before sealing, the constant-boiling hydriodic acid can be preserved in a satisfactory condition for some

time. Where the introduction of an impurity is not objectionable, the acid may be stabilized somewhat toward air oxidation by the addition of 1 to 2 per cent by volume of 50 per cent hypophosphorous acid solution. As much as 450 g. of iodine may be converted to hydriodic acid in 2 hours by this procedure.

B. BY CATALYTIC UNION OF THE ELEMENTS

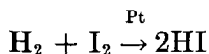

SUBMITTED BY E. R. CALEY* AND M. G. BURFORD†
 CHECKED BY G. B. HEISIG‡ AND J. J. LINGANE‡

The catalytic method^{6,7} for the preparation of hydrogen iodide with the subsequent absorption of the gas in water to form hydriodic acid has the advantage that a very pure product of any desired concentration up to that of the fuming acid may be prepared in a single operation.

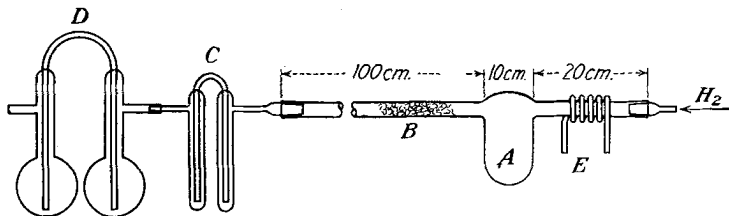

FIG. 30.—Catalytic synthesis of hydrogen iodide.

Traces of oxygen in the hydrogen entering the train should be removed by scrubbing through a spiral gas-washing bottle containing an efficient absorbent such as Fieser's solution.⁵ This is followed by an ordinary wash bottle containing concentrated sulfuric acid to dry the gas before it enters the special reaction tube. Some silver sulfate should be added to the sulfuric acid to detect any hydrogen sulfide that may have formed from the decomposition of the Fieser's solution.

* Princeton University, Princeton, N. J.

† Wesleyan University, Middletown, Conn.

‡ University of Minnesota, Minneapolis, Minn.

The reaction tube* (Fig. 30), constructed from pyrex glass tubing, consists of a bulb *A*, 6.5 cm. in diameter and 10 cm. deep, to which are sealed at the top two tubes *E* and *B* 2 cm. in diameter and approximately 15 to 20 cm. and 80 to 100 cm. in length. These are attached to the rest of the train by ground-glass joints which are sealed with a small amount of 85 per cent phosphoric acid. The longer arm is filled with loosely packed platinized asbestos† for a distance of about 20 cm. beginning 5 cm. from the bulb. This portion should be supported for nearly its entire length by sections of iron pipe sawed in halves lengthwise or by a piece of angle iron covered with asbestos paper. For the purpose of cooling the short arm *E* so that hot iodine does not sublime back, there is provided a short, loose spiral of lead or copper tubing through which cold water circulates. The entire reaction tube should be inclined slightly so that any liquid condensing in *E* will run back into the bulb. Following the reaction tube is the empty vessel *C*, cooled by an ice-salt mixture, which serves as a trap to condense any iodine that may escape from the tube. The ground-glass joint between *D* and *C* is sealed with a drop of water.

The amount of iodine placed in the bulb and the volume of water initially in the absorption vessel will

* If acid of extreme purity is not essential, the apparatus may be somewhat simplified. Corks may be used for both ends of the reaction tube and for the vessels that follow it in the train. They may need replacing at the end of four or five runs, but they apparently introduce very little impurity into the product. In no case should rubber stoppers or tubing be used where iodine or hydrogen iodide may come in contact with them, since they are attacked rapidly and introduce impurities.

The vessel *C* may be replaced by two empty gas-washing bottles so arranged that the gas enters through the short arm, and *D* may be replaced by the more conventional type of gas-absorption vessel in which the gas enters through a tube with a funnel-shaped orifice dipping slightly below the level of the liquid. If a cylindrical vessel is used, it may conveniently be graduated so the density of the acid can be estimated quickly.

† The platinized asbestos is prepared by soaking 3 g. of asbestos fiber in a solution made from 7 ml. of 10 per cent chloroplatinic acid. The solution and its contents are evaporated to dryness while stirring, and the product ignited at red heat.

depend upon the volume and the concentration of acid desired. For the purpose of describing the method of operating the apparatus, specific directions are given below for preparing acid having a concentration approximately that of the constant-boiling mixture. The apparatus is charged by placing 100 g. of iodine* in the bulb of the reaction tube and 50 ml. of water in the absorption vessel. The air in the apparatus is displaced by nitrogen, and the nitrogen is then flushed out with a gentle stream of hydrogen for about one hour.† At the end of this time, the portion of the catalyst mass nearest the bulb is heated by placing a Bunsen burner furnished with a wing top under the supported tube with the flame regulated in such a way that the tube surrounding that part of the platinized asbestos attains a low red heat. The iodine bulb is immersed in an oil bath at 160°C. or is heated with a low flame to such a temperature that only a slight purple color due to iodine vapor is observable at the cooler end of the catalyst mass. The flow of hydrogen is regulated so that it is always in slight excess. Some iodine will condense in the short tube attached to the bulb, and this should be vaporized from time to time by heating. A small amount of iodine escapes combination, and most of this will condense in the empty part of the long tube just beyond the catalyst. In some cases, especially when operating with large initial amounts of iodine, it will be necessary, in order to prevent the apparatus from being clogged, to drive this uncombined iodine farther along the tube from time to time by gentle heating. After all the iodine in the bulb has been vaporized, the passage of hydrogen should be continued until the catalyst mass has cooled. At the rate of flow recommended, about 3 hours will be required to convert 100 g. of iodine. The

* The purity of the product is largely dependent on the purity of the iodine employed. If an intimate mixture of iodine and potassium iodide (5 per cent) is placed in the bulb *D*, a product containing less chloride and bromide will be obtained.

† If the oxygen is not removed before the hydrogen is admitted, an explosion may be initiated by the catalyst in the reaction tube.

yield of hydrogen iodide should be 78 to 80 per cent. About 70 ml. of acid having a specific gravity around 1.75 will be obtained. The iodine vapor may be passed through the catalyst mass more rapidly, but the percentage of conversion will be somewhat reduced. However, if allowance is made for the uncombined iodine recovered from the empty part of the reaction tube, the yield in all cases is about 95 per cent. To prepare fuming acid, a proportionally larger initial weight of iodine must be taken. For example, by starting with 135 g. of iodine and 50 ml. of water the product had a volume of 78 ml. and a specific gravity of 1.97. As much as 300 g. of iodine may be vaporized in a single run without danger of clogging the apparatus, but the passage of such a large quantity at one time is tedious because of the time involved.

Iodine may be regarded as the chief impurity likely to be present, but the acid obtained should be only slightly colored by dissolved iodine. When not objectionable, the acid may be stabilized as described in procedure A.

References

1. COURTOIS: *Ann. chim. phys.*, [1] **88**, 305 (1813).
2. GAY-LUSSAC: *Ann. chim. phys.*, [1] **91**, 9 (1814).
3. TURNER: *Edinburgh Phil. J.*, **11**, 99, 311 (1824).
4. VANINO: "Handbuch der präparativen Chemie," 3d ed., Vol. I, p. 63, Verlag von F. Enke, Stuttgart, 1925.
BLANCHARD and PHELAN: "Synthetic Inorganic Chemistry," 3d ed., p. 122, John Wiley & Sons, Inc., New York, 1922.
5. FIESER: *J. Am. Chem. Soc.*, **46**, 2639 (1924).
6. BODENSTEIN: *Z. physik. Chem.*, **13**, 59 (1894); *ibid.*, **29**, 295 (1899).
7. BATES and LAVIN: *J. Am. Chem. Soc.*, **55**, 81 (1933).

55. POTASSIUM IODIDE FOR USE AS A PRIMARY STANDARD

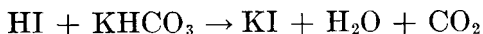

SUBMITTED BY J. J. LINGANE* AND I. M. KOLTHOFF*

CHECKED BY JOHN C. BAILAR, JR.†

Potassium iodide is not easily purified by the usual methods of recrystallization because of the great solubility of the salt and because of the doubtful removal of possible traces of chloride and bromide. A very pure product may be easily prepared, however, by synthesis from pure hydriodic acid and purified potassium bicarbonate.

Before the salt can be used as a standard substance, it must be melted to remove the last traces of water and iodine and to decompose any possible traces of hypoiodite or iodate that may have been formed during its synthesis.

When potassium iodide is melted in air or even in pure dry nitrogen,¹ the fused salt becomes alkaline as a result of hydrolytic and thermal decomposition:

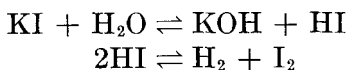

The amount of decomposition may be decreased by mixing the salt with a small amount of pure ammonium iodide before melting. The ammonia and hydrogen iodide, which result from the thermal decomposition of the ammonium iodide, repress the decomposition of the alkali iodide by a mass-action effect.

A simpler and more satisfactory way to prevent the decomposition is that of simply melting the salt in pure dry hydrogen. The hydrogen, and the small amount of free iodine contained in the salt prepared as described above, *completely* prevent the hydrolytic decomposition.

* University of Minnesota, Minneapolis, Minn.

† University of Illinois, Urbana, Ill.

Procedure

Pure concentrated hydriodic acid for use in this preparation is synthesized directly from purified iodine and hydrogen as described in synthesis 54. Potassium bicarbonate is purified by repeated crystallization from water at 70°C., in an atmosphere of carbon dioxide.

Place 250 ml. of hydriodic acid solution containing 75 g. of hydrogen iodide (slight excess) in a 500-ml. Erlenmeyer flask through which is bubbling a rapid stream of hydrogen. Add 130 g. of potassium bicarbonate in small portions, and then heat the solution to incipient boiling under hydrogen. Quickly filter through a sintered-glass filtering crucible into another 500-ml. flask. Evaporate the deeply colored (free iodine) but clear solution on an *electric* hot plate, with continuous passage of hydrogen until a considerable quantity of potassium iodide separates out. After cooling to room temperature, filter off the salt on a sintered-glass filtering funnel, and evaporate the filtrate further to obtain a second crop. Total yield 174 g. (77 per cent). Dry the slightly yellow (free iodine) salt, and store in a desiccator over fused potassium hydroxide.

Place the dry salt in a platinum boat in a silica combustion tube in an electric-tube furnace. Flush the air out of the cold tube by the rapid passage of hydrogen for a few minutes. Then over a period of 30 minutes bring the temperature of the furnace to 700 to 725°C., and hold for 10 minutes to allow time for the salt to melt (m. 680°C.). Allow the fused salt to cool to below 200°C. in hydrogen, remove to a desiccator, and store there until needed.

The fused salt may be weighed with no special precautions against atmospheric moisture, as long as the relative humidity of the air is below 70 per cent.

Solutions of the salt, which had been melted in hydrogen, were always perfectly clear and colorless. The fused salt was also perfectly neutral, as shown by the fact that solu-

tions of the salt had the same pH as the water in which it was dissolved.

Potassium iodide prepared as described has been used in a very careful study of the absolute accuracy of the potentiometric iodide-silver titration,² by comparing it directly against pure silver. The ratio KI:Ag found in this way agreed to within 0.02 per cent with the theoretical ratio. This small deviation is to be attributed to a slight absorption of iodide ions by the silver iodide at the potentiometric end point and not to an impurity in the potassium iodide.

References

1. BAXTER and BRINK: *J. Am. Chem. Soc.*, **30**, 46 (1908).
2. KOLTHOFF and LINGANE: *J. Am. Chem. Soc.*, **58**, 1524 (1936).

56. IODINE MONOCHLORIDE

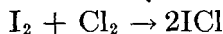

SUBMITTED BY J. CORNOG* AND R. A. KARGES*
CHECKED BY L. A. TEST†

Iodine monochloride has been prepared by leading chlorine over solid iodine and distilling the crude product. Despite improvements to obtain a more nearly pure product, this method remains a tedious and time-consuming process.

Procedure¹

Approximately 300 ml. of liquid chlorine is led directly from a cylinder of chlorine (commercial) into a tared 500-ml. flask cooled with a mixture of solid carbon dioxide and ether. A weighed quantity of solid iodine, roughly one-half of the molar equivalent of the chlorine in the flask, is added. The equivalence may vary rather widely, but the weight should be accurate. After the addition of iodine, the contents of the flask congeal to a solid. The flask is

* State University of Iowa, Iowa City, Iowa.

† Purdue University, Lafayette, Ind.

removed from the cooling mixture and allowed to warm to room temperature. During the warming, any uncombined chlorine evaporates.

The weight of the flask and contents is next determined. Since the weight of the iodine added and the tare weight of the flask are known, the weight of the chlorine is determined by difference. The weight of both chlorine and iodine being known, the quantity of solid iodine that must be added to cause the composition of the impure product to correspond to that implied by the formula ICl is computed and added. The flask is closed with a glass stopper and allowed to stand in a liquid condition for 24 hours or longer. The freezing point of the iodine monochloride is usually within 0.1°C . of that of the pure substance.

One or two recrystallizations usually suffice to obtain the pure iodine monochloride. In this connection, the word "crystallization" implies the gradual cooling of liquid iodine monochloride until approximately 80 per cent of it has solidified, then decanting off the portion that still remains liquid.

The following manipulative observations are helpful. Iodine monochloride vigorously attacks cork, rubber, and the human skin; hence contacts with these substances should be avoided. A dilute (6N) solution of hydrochloric acid is an effective antidote for skin burns. Although iodine monochloride in bulk is not notably hygroscopic, yet small quantities of moisture from the air or starting materials will noticeably depress the freezing point. Hence exposure to moisture should be reduced to a minimum. Exposure to atmospheric moisture produces a film of iodine pentoxide on the glass of the containing vessel.

The purity of iodine monochloride prepared in the foregoing manner is attested, first, by its freezing point of 27.19° as compared to 27.20° as found by Stortenbecker^{2,3} and second, by chemical analysis¹ (the variation from the theoretical composition was never more than 0.2 per cent, generally within 0.1 per cent), and, third by the constancy

of the value for the electrical conductance of the chloride obtained in different runs.

Properties

Solid iodine monochloride exists in two forms. The brownish-red tablets of the β form (m. 13.9°C.) are labile and pass readily into the ruby-red needles of the α form (m. 27.19°C.).* Since iodine monochloride dissociates on boiling at atmospheric pressure, its boiling point is not definite. The literature gives values from 94.7° to 102°C. Calculations from vapor-pressure data give 33.4 cal. as the value of the entropy of vaporization at a vapor concentration of 0.00507 mol per liter. Iodine monochloride must therefore be an associated or polar liquid.

References

1. CORNOG and KARGES: *J. Am. Chem. Soc.*, **54**, 1882 (1932).
2. STORTENBECKER: *Rec. trav. chim.*, **7**, 158 (1888).
3. STORTENBECKER: *Z. physik. Chem.*, **10**, 192 (1892).

57. IODINE TRICHLORIDE

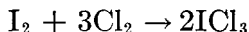

SUBMITTED BY H. S. BOOTH† AND W. C. MORRIS†
CHECKED BY L. F. AUDRETH‡

The usual method of preparing iodine trichloride by subliming iodine into a current of chlorine gas is tedious and gives a poor yield of a product contaminated with iodine and iodine monochloride. Furthermore, the product deposits on the sides of the flask in crusts which are difficult to remove.

The procedure described here consists in adding finely powdered iodine to an excess of liquid chlorine,¹ which is then boiled away.

* These colors can be seen in thin crystals only by transmitted light. More frequently, the crystals appear black.

† Western Reserve University, Cleveland, Ohio.

‡ University of Illinois, Urbana, Ill.

Procedure

Chlorine gas from a cylinder passes through a flask used as a safety trap and then is condensed in a large test tube (or flask for larger amounts) by surrounding it with a mixture of acetone or ether and solid carbon dioxide. The powdered iodine is added slowly and immediately is converted to flocculent, orange, iodine trichloride which settles gradually. When the liquid space is filled with the trichloride, the excess chlorine is evaporated into a second container where the process may be repeated.

Properties

The product is a fluffy orange powder decomposing rapidly at 47 to 62°C. and should be immediately placed in a dry bottle. A sample prepared in this way analyzed for chlorine, 45.7 per cent (calc. 45.61 per cent) and for iodine, 54.5 per cent (calc. 54.39 per cent). The yield is 100 per cent based on the iodine used.

Reference

1. THOMAS and DEPUIS: *Compt. rend.*, **143**, 282 (1906).

58. THE PERIODATES OF SODIUM, POTASSIUM, AND BARIUM

SUBMITTED BY H. H. WILLARD*

CHECKED BY E. H. HUFFMAN† AND LOUIS GORDON†

The periodates of the alkali metals¹ are best prepared by oxidation of iodate by chlorine.² The oxidation can also be effected by persulfate,³ but this is inferior as a preparative method and is to be recommended only when no ready supply of chlorine is available.

Procedure

Sodium Iodate. This compound, from which all of the following are prepared, may be readily obtained by oxida-

* University of Michigan, Ann Arbor, Mich.

† University of Kentucky, Lexington, Ky.

tion of iodine with an excess (at least 20 per cent) of sodium chlorate.

In a 5-l. flask, 125 g. of pure sodium chlorate is dissolved in 500 ml. of water at 45°C. After acidification with 2 ml. of concentrated nitric acid, 100 g. of iodine is added. The mixture is warmed until reaction just begins (at 50°C., if the acidity is correct). To prevent loss of iodine, the mouth of the flask is lightly closed with an inverted beaker. Provision should be made for immersing the flask in cold water in case the reaction becomes too vigorous. Complete disappearance of the iodine ordinarily requires 10 or 15 minutes. The iodate solution is then ready to be oxidized to periodate.

A. SODIUM PARAPERIODATE, CHLORINE METHOD

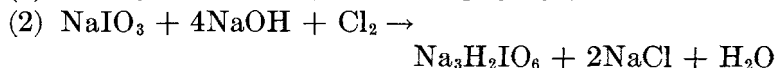
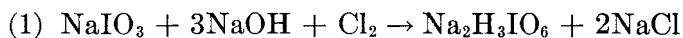

The best yields are obtained when the alkali concentration is near that expressed by (2). Under these conditions, nearly pure $\text{Na}_3\text{H}_2\text{IO}_6$ is formed although a small amount of the other salt may be present.

To a solution of sodium iodate from 100 g. of iodine are added 140 g. of solid sodium hydroxide and, if necessary, 100 to 200 ml. of water to allow ready mixing. The mixture is heated to boiling, and chlorine is passed in as rapidly as possible without spattering. This is best accomplished by passing the chlorine in through a glass tube not less than 1 cm. in inside diameter, which is used as a hand stirrer. (A smaller tube is apt to clog.) Best yields are obtained when the solution is boiled rapidly and stirred vigorously. The reaction is finished when the alkali has been neutralized and chlorine is no longer absorbed (10 to 15 minutes).

The solution is made slightly alkaline with sodium hydroxide (to change any $\text{Na}_2\text{H}_3\text{IO}_6$ to the less soluble $\text{Na}_3\text{H}_2\text{IO}_6$), cooled, and filtered. The precipitate is washed several times with cold water (below 20°C.) and dried at

110°C. The yield is about 225 g. (97 to 98 per cent). The I_2O_7 content is 62.2 to 62.8 per cent; $Na_3H_2IO_6$ demands 62.23 per cent.*

B. SODIUM PARAPERIODATE, PERSULFATE METHOD†

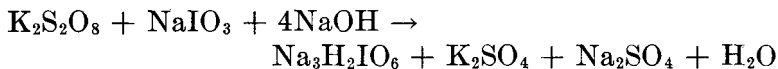

To the sodium iodate solution from 100 g. of iodine 40 g. of sodium hydroxide is added in portions.‡ After dilution to 1200 ml., the solution is heated to boiling and vigorously stirred mechanically while 213 g. of potassium persulfate is added and then 170 g. of sodium hydroxide in small portions. The boiling is continued for 15 minutes. The solution is cooled to 40°C., filtered on a fritted-glass filter (or decanted), and the precipitate is washed with cold water. If cooled below 40°C., large amounts of sulfate crystallize. Even when prepared as described, the precipitate usually gives a test for sulfate after numerous washings. After drying at 110°, the yield is 223 to 227 g. of 94 to 97 per cent purity, based on the I_2O_7 content.

Sodium Metaperiodate.



For each 100 g. of sodium paraperiodate, 200 ml. of water and 55 ml. of concentrated nitric acid (a 50 per cent excess)

* The I_2O_7 content of the periodates described is determined as follows: The weighed sample is covered with 20 ml. of water, and 5 to 10 drops of 6N HCl is added to hasten solution. No chlorine is liberated from the acid of this concentration. The solution is diluted to 100 ml., made just alkaline to phenolphthalein paper with borax, buffered with borax and boric acid (MÜLLER and WEGELIN: *Z. anal. Chem.*, **52**, 755-759 (1913), and an excess of potassium iodide is added. Under these conditions, the periodate is reduced to iodate. The liberated iodine is titrated with 0.1N arsenite.

‡ The basicity of sodium paraperiodate is determined by titration with acid after reduction to iodate by boiling with neutral hydrogen peroxide:

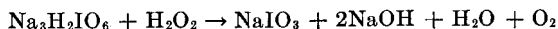

† The presence of ammonium salts is very detrimental to this reaction.

‡ Some precipitation occurs as a result of oxidation by the chlorine formed in the preparation of the iodate.

are added. If not clear, the solution is filtered through asbestos and evaporated on a steam bath until crystals appear. The solution is cooled to 20°C., filtered, and the precipitate is washed with cold water, centrifuged, and dried at 110°C. It forms brilliant, clear crystals.

If the solution is cooled to too low a temperature, white crystals of $\text{NaIO}_4 \cdot 3\text{H}_2\text{O}$ are formed. The transition point is 34.4°C.,¹ but the solution can be cooled much below that point if none of the trihydrate phase is present.

Yields of 61 to 62.1 g. (84 to 86 per cent) are obtained, of purity 99.5 to 99.8 per cent. The remaining periodate may be separated from the sodium nitrate by adding potassium nitrate, which precipitates potassium periodate. This gives an additional 10 to 12 g. (13 to 15 per cent).

Potassium Metaperiodate. This compound can be obtained in good yield by oxidation of the iodate with chlorine in alkaline solution. Since the soluble salt $\text{K}_4\text{I}_2\text{O}_9$ exists in alkaline solution instead of the insoluble KIO_4 ,¹ no precipitation occurs until all of the alkali is neutralized.

The directions for the preparation differ from those for the preparation of sodium paraperiodate only in that 135 g. of potassium chlorate is used and 195 g. of pure potassium hydroxide. Since the latter always contains water, its percentage purity must be known. The yield is nearly 180 g. (98 to 99 per cent), and the purity is 99.5 per cent.

Impure periodate residues are conveniently recovered by adding potassium nitrate to the acid solution, as described under sodium metaperiodate.

Barium Paraperiodate.

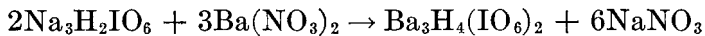

The sodium periodate from 100 g. of iodine (about 225 g.) is suspended in a liter of boiling water containing 10 ml. of concentrated nitric acid (to increase the solubility of the periodate). A moderate excess of barium nitrate (325 g.) dissolved in hot water is added, and the solution is boiled for 1½ to 2 hours with vigorous stirring. The solution

then is neutralized with barium hydroxide and allowed to cool. The barium periodate which crystallizes is washed with hot water several times by decantation (stirring up the crystals each time) and then on a Büchner funnel. If the salt gives more than a faint flame test for sodium, it is again boiled with barium nitrate solution containing nitric acid and treated as before.

The yield is nearly quantitative. Although the salt cannot be analyzed directly for I_2O_7 because of its insolubility in the buffered solution, a nearly pure product is indicated by the results obtained when it is used to prepare periodic acid.

The same salt may be prepared from potassium metaperiodate by adding two equivalents of potassium hydroxide and proceeding as with the sodium salt.

If the salt is to be used for preparing periodic acid, it need not be dried.

References

1. HILL: *J. Am. Chem. Soc.*, **50**, 2678 (1928).
2. LANGLOIS: *Ann. chim. phys.*, [3], **34**, 257 (1852); *Ann.* **83**, 153 (1852).
3. MÜLLER and JACOB: *Z. anorg. Chem.*, **82**, 308 (1913).

59. PERIODIC ACID

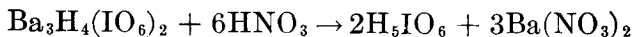

SUBMITTED BY H. H. WILLARD*

CHECKED BY E. H. HUFFMAN† AND LOUIS GORDON†

Of the older methods for the preparation of periodic acid, the most satisfactory for obtaining large quantities is the electrolytic oxidation of iodic acid at an anode of platinum plated with lead dioxide, the cathode solution being dilute nitric acid.¹ The iodic acid for this preparation is conveniently prepared by the electrolytic oxidation of iodine.¹ However, periodic acid prepared in this way often contains

* University of Michigan, Ann Arbor, Mich.

† University of Kentucky, Lexington, Ky.

considerable iodic acid after a year, even when carefully protected from light and dust, doubtless due to traces of platinum derived from the electrode.

The following method of making periodic acid is adapted to large-scale preparation, and the acid so prepared is stable at least over a period of several years. It depends upon the fact that barium nitrate is insoluble in nitric acid of sp. gr. 1.42, whereas periodic acid is readily soluble:

Temp., C.	H ₅ IO ₆ , g. per 100 ml.	H ₅ IO ₆ , g. per 100 g. solution
-12° ± 1°	5.68	3.95
26° ± 0.05°	7.82	5.41

The solubility rises rapidly above 25°C. and is about ten times as great in water as in concentrated nitric acid. If dry barium periodate is treated with concentrated nitric acid, the barium nitrate is so finely divided that it is difficult to filter and wash. This is avoided by using more dilute acid or by treating the moist salt with concentrated acid.

Procedure

One hundred grams of barium periodate is moistened with 75 ml. of water and treated with 200 ml. of colorless* nitric acid (sp. gr. 1.42). The mixture is kept at 60 to 70°C. for an hour with frequent stirring, cooled to 30 to 40°C., and the barium nitrate filtered off on a fritted-glass Büchner funnel. It is washed with colorless, concentrated nitric acid until free from periodate, which is best done by thoroughly stirring it with the washing acid.

The filtrate and washings are concentrated at 60 to 70°C. *in vacuo* (water pump). If the solution becomes cloudy

* It is essential that the acid used in this preparation be free from nitrous fumes and nitrous acid, which reduce periodic acid to iodic acid, which may also be formed if the temperature gets too high at any time. If, in spite of precautions, some iodic acid is formed, it may be removed from the periodic acid by recrystallization from colorless, concentrated nitric acid, in which it is but slightly soluble.

because of the separation of a little barium nitrate or iodic acid, it is filtered, the precipitate is washed with nitric acid, and the filtrate and washings are evaporated until periodic acid begins to separate. Sometimes a little more barium nitrate separates first and must be removed. Upon cooling, clear, brilliant crystals of periodic acid are formed. The solution shows a great tendency to supersaturation, and ample time should be allowed after cooling before the crystals are removed. These are centrifuged and dried in the air or *in vacuo* at 50°C. The mother liquor is evaporated for a second recovery. The yield is 46 to 51 g. (90 to 96 per cent), and the purity 99.5 to 99.9 per cent. The addition of potassium nitrate to the second mother liquor recovers the remaining periodic acid as potassium metaperiodate.

As much as 500 g. of barium periodate can easily be carried through this process.

The preparation conveniently starts with iodine which can be converted through the sodium and barium salts to the acid without drying the intermediate products. From 200 g. of iodine, 302 to 326 g. of periodic acid (about a 90 per cent yield) can be obtained. A run can easily be made in a day. The principal losses are due to the volatilization of iodine in the first step, the solubility of sodium periodate, and reduction of the acid to iodic acid. The barium nitrate and much of the nitric acid are recovered for further use.

Finely divided platinum catalyzes the decomposition of periodic acid, so even traces of this metal must be avoided.

A satisfactory vacuum-distillation apparatus is one that resembles a vacuum desiccator with a tube ground into the cover and having a side arm.* If the ground surface between vessel and cover is improved by grinding with the finest carborundum or emery flour and then with rouge, it will hold a vacuum sufficiently well without any lubricant—

* An apparatus of this type is sold by the Corning Glass Works.

an essential feature, because periodic acid is so readily reduced.

It is essential that the hot nitric acid shall not come into contact with rubber, in order that no nitrous acid may be formed. To avoid this, the top of the tube ground into the cover is sealed off, and the side-arm delivery tube lengthened to at least 25 cm. The side arm is then inserted 7 to 8 cm. below the water-cooled part of the condenser tube, which should allow of very little clearance, in order that no nitric acid may come in contact with the rubber stopper joining the two.

The still is conveniently heated by placing on an asbestos pad over an electric hot plate with adjustable temperature control. If much refluxing occurs, an asbestos shield should be formed around the still.

Reference

1. WILLARD and RALSTON: *Trans. Electrochem. Soc.*, **62**, 239 (1932).

60. METALLIC RHENIUM

SUBMITTED BY LOREN C. HURD* AND EUGENE BRIMM*
CHECKED BY W. A. TAEBEL† AND B. S. HOPKINS†

Two methods are in common use for the production of metallic rhenium. The first of these involves a direct reduction of commercial potassium perrhenate (procedure A) and yields a product that usually contains a small amount of alkali but is pure enough for most preparative purposes. The second method (procedure B) is slightly more complicated in that a preliminary precipitation of rhenium heptasulfide is followed by conversion to ammonium perrhenate which is subsequently reduced to the metal.^{1,2} Metallic rhenium so produced is usually purer than that prepared by direct reduction of the potassium salt.

* University of Wisconsin, Madison, Wis.

† University of Illinois, Urbana, Ill.

A. BY REDUCTION OF POTASSIUM PERRHENATE



Commercial potassium perrhenate is crushed and ground to approximately 60 mesh in an agate mortar and dried at 175°C. for an hour. It is transferred to a silver boat which is placed in a porcelain or other refractory combustion tube. The area above and in the vicinity of the boat should be protected by an iron shield. The air in the tube is displaced by hydrogen which has been passed through alkaline pyrogallol and concentrated sulfuric acid. A sulfuric acid trap prevents backward diffusion of air into the tube. When the air has been completely displaced, the tube is heated by means of a small furnace to a temperature of about 250°C. At the end of 2 hours, the temperature is slowly raised to 500°C.* After 2 hours at this temperature, the furnace is disconnected, and the tube and its contents allowed to cool. The silver boat is removed and quickly placed in a beaker of water. The reduction product is washed four or five times by decantation with boiling water. It is finally transferred to a sintered-porcelain crucible or a sintered-glass filter and washed several times with small portions of hot water followed by cold water, alcohol, and ether. The air-dried product usually contains a small amount of alkali and apparently is always contaminated with oxides of rhenium. The product is transferred to a porcelain or quartz boat, placed in a quartz combustion tube, and heated in hydrogen at a temperature of 1000°C. for 2 hours. After cooling to room temperature, the soluble compounds† are again extracted with hot water,

* The temperature at which the reduction is carried out must be approached slowly in order to prevent an agglomeration of potassium perrhenate, KReO_4 .

† The washings and filtrates contain appreciable quantities of rhenium. This material may be recovered by concentrating the solutions and oxidizing the rhenium to the perrhenate with 30 per cent hydrogen peroxide. The addition of potassium hydroxide results in the formation of potassium perrhenate which is only slightly soluble in alkaline solutions and crystallizes out on cooling.

and the reduction at 1000°C. repeated. At the end of 2 hours, the hydrogen is displaced with oxygen-free nitrogen, and the tube and its contents allowed to cool to room temperature. Throughout the preparation, care must be taken to permit the tube to become cold before removing the metal. If this precaution is not observed, the product may be oxidized upon exposure to air.

Metallic rhenium prepared by this method is generally between 99.0 and 99.8 per cent pure. The chief impurity is potassium, probably as potassium hydroxide. The product is a dense gray-black powder. The yield is between 85 per cent and 95 per cent based upon the potassium perrhenate used.

B. BY REDUCTION OF AMMONIUM PERRHENATE

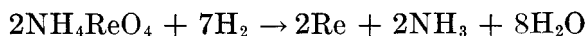

Commercial potassium perrhenate is crushed to about 60 mesh and dissolved in hot 10 per cent hydrochloric acid (weight basis). Approximately 100 ml. of acid should be used per gram of rhenium. A rapid stream of hydrogen sulfide is passed into the solution until the precipitated sulfide has coagulated. The precipitate is collected on the asbestos pad of either a Büchner funnel or a Geilmann filter stick³ and washed well with hydrogen sulfide solution and then with distilled water. The sulfide together with the asbestos pad is transferred to a beaker containing ammonia water (10 per cent by weight). Twenty-five milliliters of this solution are used for each gram of potassium perrhenate. The suspension is heated to 40°C., and 30 per cent hydrogen peroxide is added until the black sulfide is completely oxidized and the solution is colorless. The asbestos is filtered out, and the solution evaporated to dryness on a water bath. The residue is dissolved in hot water, a few drops of nitric acid is added, and the solution is heated to boiling to coagulate the small amount of silica that usually appears at this point. Following filtration, the solution is made faintly ammoniacal and

evaporated to dryness. The product, which consists of ammonium perrhenate and ammonium nitrate, is dried at 110°C., transferred to a quartz boat, and reduced in a quartz tube with a rapid stream of dry hydrogen. The temperature should be raised slowly in order to avoid loss of product by sublimation.* Final reduction is carried out at about 1000°C. for 2 hours. After cooling in nitrogen, the product may be removed. The yield is 80 to 90 per cent based upon KReO_4 used, and the rhenium so prepared is very nearly 100 per cent pure. It has a distinct metallic appearance in contrast to the gray-black powder obtained by direct reduction of potassium perrhenate.

References

1. HEYNE and MOERS: *Z. anorg. allgem. Chem.*, **196**, 143 (1931).
2. BILTZ, W., LEHRER, and MIESEL: *Nachr. Ges. Wiss. Göttingen, Geschaft. Mitt. Math. physik. Klasse*, III, **12**, 191 (1931).
3. GELLMANN and WEIBKE: *Z. anorg. allgem. Chem.*, **195**, 289 (1931).

61. POTASSIUM CHLORORHENITE

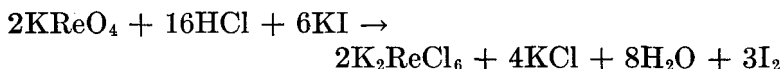

SUBMITTED BY LOREN C. HURD† AND VICTOR A. REINDERS†

CHECKED BY W. A. TAEBEL‡ AND B. S. HOPKINS‡

Potassium chlororhenite has been prepared by reducing potassium perrhenate with potassium iodide in hydrochloric acid solution.¹⁻⁴ The identity of the product has been questioned, and various formulae have been assigned to the compound. The difficulties encountered in obtaining a pure product were probably due to the inclusion of a double chloride of potassium and pentavalent rhenium. It is known that the primary reduction involves formation of pentavalent rhenium.

* Ammonium perrhenate is appreciably volatile; consequently its decomposition must be carried out at as low a temperature as possible.

† University of Wisconsin, Madison, Wis.

‡ University of Illinois, Urbana, Ill.

Procedure

Eight grams of commercial potassium perrhenate is finely pulverized and intimately mixed with 16 g. of powdered potassium iodide. This mixture is placed in a small casserole, covered with a glass, and treated with 50 ml. of hydrochloric acid (sp. gr. 1.2). The casserole and contents are gently warmed until the bulk of the iodine liberated condenses on the cover glass. The glass is then removed, and the solution heated for 30 minutes at a temperature just below boiling.

Acid lost by evaporation is replaced from time to time. The solution is then evaporated almost to dryness, and the residue taken up with 75 ml. of hot 10 per cent hydrochloric acid. (Some of the product remains undissolved.) Following digestion below the boiling point for 10 minutes, the casserole is cooled in ice, and the brownish-yellow product is filtered* on to a sintered-glass filter and washed with cold 10 per cent hydrochloric acid.

The impure product is transferred to a beaker and digested with 250 ml. of hydrochloric acid (sp. gr. 1.2) for several hours until the solution is a clear green. The solution is then evaporated to a volume of about 100 ml., cooled slowly to 20°C., and then placed in an ice bath.

The bright-green crystalline product is collected on a glass filter, washed first with three 5-ml. portions of cold 10 per cent hydrochloric acid, and then washed with alcohol and ether. The air-dried product is bright green, and the yield is in the neighborhood of 85 per cent of theory. Analysis according to either the nitron⁵ or the tetron⁶ methods yields values in harmony with those calculated for K_2ReCl_6 .

References

1. DAHLMANN: *Diss. Göttingen*, 28 (1933).
2. ENK: *Ber.*, 64, 791 (1931).

* The filtrate usually contains about 0.5 g. of rhenium. For the recovery of this material, see p. 176.

3. NODDACK and NODDACK: *Z. anorg. allgem. Chem.*, **215**, 129 (1933).
4. SCHMID: *Z. anorg. allgem. Chem.*, **212**, 187 (1933).
5. GEILMANN and WEIBKE: *Z. anorg. allgem. Chem.*, **195**, 289 (1931).
6. GEILMANN and HURD: *Z. anorg. allgem. Chem.*, **213**, 336 (1933).

62. RHENIUM PENTACHLORIDE

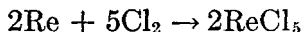

SUBMITTED BY LOREN C. HURD* AND EUGENE BRIMM*
CHECKED BY W. A. TAEBEL† AND B. S. HOPKINS†

Rhenium pentachloride is prepared by the direct combustion of metallic rhenium in dry chlorine.¹

Procedure

Metallic rhenium,‡ prepared by the reduction of either potassium perrhenate (see synthesis 60A) or ammonium perrhenate (see synthesis 60B), is placed in a previously ignited porcelain boat and inserted in a pyrex combustion tube of the type shown in Fig. 31. All air in the train is displaced with nitrogen that has been passed through alkaline pyrogallol *A* and sulfuric acid *B*.

When the system is free from oxygen, all portions of the tube are flamed to drive out moisture. If any water remains, it will react with rhenium pentachloride to form oxychlorides. When the tube is dry, the nitrogen is cut off, and chlorine introduced. Commercial chlorine that has been dried by sulfuric acid *C* has been found satisfactory.

The boat and its contents are heated either with a wing-top Bunsen burner or with a short electric furnace. If a burner is used, the tube should be protected with a wire gauze. Although combustion usually takes place rapidly at about 400°C., the temperature should be so regulated that the rhenium burns slowly in an excess of chlorine. The speed of oxidation varies with the purity and state of

* University of Wisconsin, Madison, Wis.

† University of Illinois, Urbana, Ill.

‡ If the previous history of the rhenium is unknown, it should be heated in hydrogen in the manner described in the preparation of rhenium from ammonium perrhenate. This precaution must be taken in order to insure the absence of oxides which would later react to form oxychlorides.

subdivision of the rhenium. In order to safeguard against sulfuric acid being drawn into the system, the wash bottle *L* serving as a trap is reversed. Most of the rhenium compounds that are carried through the system will be absorbed in the sulfuric acid trap *M*.

When the rhenium has been completely converted to pentachloride, as is evidenced by the disappearance of all brown fumes in the neighborhood of the boat, the black

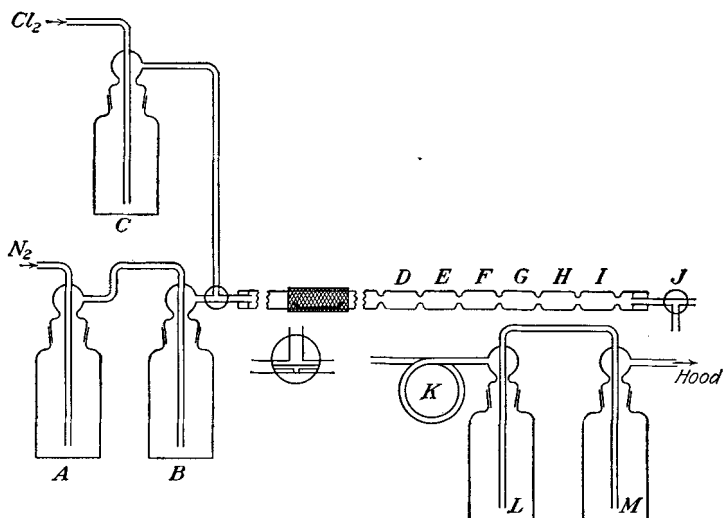

FIG. 31.—Preparation of rhenium pentachloride.

crystalline product is sublimed in a current of chlorine into the bulb *D*. A portion of the product will be found in bulbs beyond the first. The tube is then sealed off at the first constriction, stopcock *J* is closed, and the rubber tube *K* disconnected at the stopcock. The bulb train is held in a vertical position, and by gentle tapping all of the crude pentachloride is collected in bulb *D*. The stopcock lead is connected to an oil pump, and the system evacuated.*

The tube is clamped at a 45° angle, and the product slowly heated to 160°C. by means of a small electric-tube

* Because of the deleterious effect of chlorine on the pump, a tube containing silver turnings, precipitated silver, or a soda-lime tower should be placed between the bulb train and the exhaust mechanism.

furnace. A small amount of oxychloride will distill over at 50°C. and condense on the cooler portion of the tube. This should be expelled by warming gently with a small flame. When a temperature of 160° has been reached, the bulb *D* will have been emptied, and the tube may be sealed off at the second constriction. The product may all be collected in bulb *F* or, if smaller samples are desired, distributed in the remaining bulbs.

The yield of rhenium pentachloride is generally in the neighborhood of 80 per cent.

Properties

Rhenium pentachloride reacts energetically with water. If exposed to air, it fumes and evolves chlorine and hydrogen chloride.

Reference

1. GEILMANN, WRIGGE, and W. BILTZ: *Z. anorg. allgem. Chem.*, **214**, 244 (1933).

63. RHENIUM TRICHLORIDE



SUBMITTED BY LOREN C. HURD* AND EUGENE BRIMM*
CHECKED BY W. A. TAEBEL† AND B. S. HOPKINS†

Rhenium trichloride is prepared by the thermal decomposition of rhenium pentachloride in an atmosphere of nitrogen.¹

Procedure

A combustion tube of either Jena hard glass or Corning 172 is constructed similar in design to that used for the preparation of rhenium pentachloride (synthesis 62). The pentachloride is prepared in the manner previously described and sublimed into the bulb *D*. The chlorine is then turned off, and the train swept out with nitrogen. When all chlorine has been displaced, the pentachloride is

* University of Wisconsin, Madison, Wis.

† University of Illinois, Urbana, Ill.

heated cautiously in a rapid stream of nitrogen. A portion sublimes into the next bulb, leaving behind a residue of rhenium trichloride. Complete decomposition of the pentachloride is attained when no more brown fumes are evolved. The residual trichloride sublimes at a much higher temperature and in the gaseous state is green. Especial care should be taken not to overheat the trichloride. Attempts to purify rhenium trichloride by sublimation at atmospheric pressure result in extensive decomposition. The pentachloride contained in the remaining bulbs is converted in a similar manner. A small amount of rhenium usually passes over into the trap, but most of it remains behind as the crude trichloride. When the combustion tube is cold, the boat may be removed, and the trichloride removed by gentle tapping. Yield usually about 70 per cent of the theoretical.

If a pure product is desired, the tube is sealed off at the first constriction after all of the pentachloride has been decomposed. The product is shaken into bulb *D*, the tube inclined at an angle of 45° , and the chloride sublimed under reduced pressure at a temperature of 450°C . An asbestos shield placed at the point where the tube enters the furnace will assure condensation of trichloride just beyond the edge of the furnace. The product is sublimed twice, allowed to cool to room temperature, and the tube broken just above and below the point where the trichloride has formed. The dark-red crystalline mass may be powdered, transferred to a weighing bottle, and stored in a desiccator without fear of decomposition. Exposure to direct sunlight should be avoided because of the formation of oxychlorides under such conditions. The yield is usually about 60 to 65 per cent based upon the quantity of rhenium used. In one experiment, 38 g. of twice resublimed rhenium trichloride was prepared with a yield of 68 per cent.

Reference

1. GEILMANN, WRIGGE, and W. BILTZ: *Nachr. Ges. Wiss. Göttingen Geschaft. Mitt. Math. physik.*, Kl. V, 29, 579 (1932); *Chem. Abstr.*, 28, 60 (1934).

CHAPTER VIII

64. TETRAPYRIDINO-FERROUS CHLORIDE (YELLOW SALT)¹

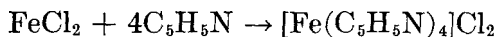

SUBMITTED BY OSKAR BAUDISCH* AND WALTER H. HARTUNG†
CHECKED BY W. O. MILLIGAN‡

“Yellow salt” is a very convenient intermediate for many synthetic reactions. It is very much more stable than the simple ferrous salts.

Procedure

About 500 ml. of pure pyridine is placed in a 1-l. round-bottom flask. It is freed from dissolved oxygen by heating it carefully to the boiling point, with a current of carbon dioxide passing through the liquid. The flask is kept filled with carbon dioxide while the liquid is allowed to cool to room temperature. A stream of carbon dioxide is then allowed to bubble through the liquid providing agitation while there is added, slowly and cautiously, 125 ml. of a saturated solution of *pure* ferrous chloride§ (neutral to Congo red).

An intense yellow color appears as soon as the first drops of the solution are added. Soon a yellow crystalline solid separates. When the action is complete, the mixture is allowed to stand for at least 12 hours under an atmosphere

* Saratoga Springs Research Institute, Saratoga Springs, N. Y.

† School of Pharmacy, University of Maryland, Baltimore, Md.

‡ Rice Institute, Houston, Tex.

§ Ferrous chloride from commercial sources may contain ferric chloride and is likely to be too acid. If this is allowed to stand in contact with excess iron, preferably powder, a satisfactory solution becomes available. If very pure derivatives are desired, the ferrous chloride may be prepared directly from pure hydrochloric acid and electrolytic iron.

of carbon dioxide. The crystals are then removed by suction (a fritted-glass suction funnel is best) and washed with a small amount of pyridine. The crystals are dried in an evacuated desiccator over calcium chloride. Yield 180 to 185 g. $[\text{Fe}(\text{C}_5\text{H}_5\text{N})_4]\text{Cl}_2$.

Properties

The product is a yellow crystalline substance which is stable if kept in sealed containers. On continued exposure to air, the characteristic yellow color becomes a pale yellow or even white.

Reference

1. GROSSMAN and HÜNSELER: *Z. anorg. Chem.*, **46**, 370 (1905).

65. GAMMA FERRIC OXIDE MONOHYDRATE AND GAMMA FERRIC OXIDE

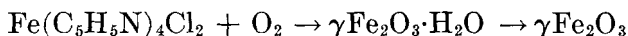

SUBMITTED BY OSKAR BAUDISCH* AND WALTER H. HARTUNG†

CHECKED BY W. O. MILLIGAN‡

Tetrapyridino ferrous chloride (synthesis 64) is dissolved in distilled water in the ratio of 20 g. per liter and placed in a flask of suitable size. Clean air or oxygen is then allowed to bubble through the solution, rapidly for about 15 minutes and then slowly for an additional 30 minutes or longer. This converts the tetrapyridino ferrous chloride complex into the orange-yellow gamma ferric oxide hydrate, $\gamma\text{Fe}_2\text{O}_3 \cdot \text{H}_2\text{O}$.^{1,2,3,4,5} The yield is substantially quantitative.

$\gamma\text{Fe}_2\text{O}_3 \cdot \text{H}_2\text{O}$ dehydrates rapidly to ferromagnetic $\gamma\text{Fe}_2\text{O}_3$ at 250°. $\gamma\text{Fe}_2\text{O}_3$, in turn, heated for an hour at 400°C. changes irreversibly to $\alpha\text{Fe}_2\text{O}_3$. In sealed tubes, along with water, either $\gamma\text{Fe}_2\text{O}_3 \cdot \text{H}_2\text{O}$ or $\gamma\text{Fe}_2\text{O}_3$ changes to $\alpha\text{Fe}_2\text{O}_3$ in an hour at 136°C. This may be done by immersing the tube containing the hydrates or oxides in a suitable bath

* Saratoga Springs Research Institute, Saratoga Springs, N. Y.

† School of Pharmacy, University of Maryland, Baltimore, Md.

‡ Rice Institute, Houston, Tex.

or by heating them in a controlled electric furnace. Obviously, either $\gamma\text{Fe}_2\text{O}_3$ or $\alpha\text{Fe}_2\text{O}_3$ may be prepared from $\gamma\text{Fe}_2\text{O}_3 \cdot \text{H}_2\text{O}$ at the same temperature.

References

1. BAUDISCH and ALBRECHT: *J. Am. Chem. Soc.*, **54**, 943 (1932).
2. BAUDISCH: *Science*, **77**, 317 (1933).
3. WELO and BAUDISCH: *Phil. Mag.*, [7] **17**, 753 (1934).
4. U. S. patents 1894749 and 1894750.
5. WELO and BAUDISCH: *Phil. Mag.* (in press).

66. BROMOPENTAMMINOCOBALTI BROMIDE

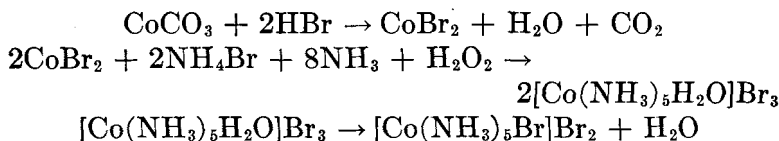

SUBMITTED BY HARVEY DIEHL,* HELEN CLARK,* AND H. H. WILLARD*
CHECKED BY JOHN C. BAILAR, JR.†

Bromopentamminocobalti bromide was first prepared by the air oxidation of an ammoniacal solution of cobalt bromide.¹ It has also been obtained from aquopentamminocobalti oxalate² and from aquopentamminocobalti hydroxide.³ The latter methods are indirect, and the yield in the air-oxidation procedure is very poor. The following procedure involves oxidation by hydrogen peroxide and was suggested by the method of Willard and Hall⁴ for the preparation of chloropentamminocobalti chloride.

Procedure

Twenty-five grams (0.21 mol) of cobalt carbonate‡ is treated slowly with 65 ml. of 42 per cent hydrobromic acid.

* University of Michigan, Ann Arbor, Mich.

† University of Illinois, Urbana, Ill.

‡ Cobalt carbonate is prepared by the addition of a solution of sodium bicarbonate to a boiling solution of cobalt chloride. The resulting precipitate is washed several times by shaking with water and filtering until the last washings give no test for chloride ion. A cobalt determination must be made on each lot of cobalt carbonate if an accurate check on the yield of the complex salt is desired.

The solution is filtered by suction through a fritted-glass filter (an asbestos mat in a Gooch crucible is satisfactory) to remove any undissolved oxide. The filtrate in a 1-l. beaker is treated with 50 g. (0.51 mol) of ammonium bromide and then with 250 ml. of concentrated ammonium hydroxide (approximately 3.5 mols of NH_3). Disregarding the pink precipitate which appears, 40 ml. of 30 per cent hydrogen peroxide (0.39 mol) is added slowly with stirring. When the vigorous effervescence has ceased, oxidation is complete. The resulting solution is dark red in color.

While still warm, the solution is placed in the hood, and a vigorous stream of air is blown through it for two or three hours to remove the excess ammonia. Concentrated hydrobromic acid is added until the rose-colored precipitate, which forms as the solution becomes neutral, persists. This precipitate is aquopentamminocobalti bromide. An excess of 50 ml. of the acid is then added, and the entire precipitate and solution are heated in an evaporating dish on the steam bath for 2 hours. The precipitate is filtered on a Büchner funnel, washed by mixing with 250 ml. of water, and again filtered. The product is then washed with four 25-ml. portions of alcohol and dried at 110°C . The finely crystalline, light-lavender product weighs 70 to 75 g., corresponding to a 90 per cent yield based on the cobalt content of the starting material. It is sufficiently pure for most purposes.

It may be recrystallized by gradually adding a 25-g. portion of the compound to a solution of 25 ml. of ammonium hydroxide in 500 ml. of water which has been heated to 90°C . The solution is filtered, 40 ml. of hydrobromic acid is added, and the whole is heated on the steam bath for 2 hours. The large purple crystals are filtered, washed with water and alcohol, and dried.

Samples were analyzed for cobalt, bromine, and ammonia. The cobalt was weighed as cobalt sulfate, and the bromine as silver bromide. Ammonia was determined by the Kjeldahl method.

TABLE I

	Co	Br	NH ₃
% calculated.....	15.36	62.46	22.18
First product:			
% found.....	15.48	62.60	22.16
Recrystallized product:			
% found.....	15.43	62.38	22.05

If the intermediate *aquopentamminocobalti bromide* is desired, that portion of it which precipitates may be filtered off, and the remainder in solution recovered by the addition of an equal volume of 95 per cent alcohol. The product is dried over sulfuric acid. Yield 75 g. (82 per cent), based on cobalt content of starting material.

The compound was analyzed in the manner already described. The water content was determined by heating a sample at 110° for 3 hours.

TABLE II

	Co	Br	NH ₃	H ₂ O
% calculated.....	14.67	59.66	21.19	4.48
% found.....	14.83	59.70	21.18	4.43

References

1. JÖRGENSEN: *J. prakt. Chem.*, [2] **19**, 49 (1879).
2. JÖRGENSEN: *Z. anorg. Chem.*, **17**, 463 (1898).
3. DUVAL: *Ann. chim.*, [10] **18**, 263 (1932).
4. WILLARD and HALL: *J. Am. Chem. Soc.*, **44**, 2220 (1922).

CHAPTER IX

67. A LABORATORY CEMENT

SUBMITTED BY W. C. FERNELIUS*

CHECKED BY W. C. JOHNSON†

A good laboratory cement (similar to commercial De Khotinsky cement) may be prepared cheaply in the laboratory by mixing gradually 3 lb. of shellac scales with 1 pt. of North Carolina pine-tar oil maintained at not over 140°C. Heating on an electric hot plate (to prevent fire hazard) with frequent stirring is continued until the mixture becomes uniform throughout, when it is poured out on a cool surface. While cooling, the cement may be worked into any desirable shape. If a harder or softer cement is desired, it may be obtained by correspondingly increasing or decreasing the amount of shellac. Regardless of proportions, this cement will be found to suffer no deterioration on repeated heating and will not carbonize should it become ignited during application to a piece of apparatus. This cement is excellent for glass-to-glass seals and will hold a high vacuum, since it has a very low vapor pressure. It is not always satisfactory, however, for glass-to-metal seals, but by previously wiping the metal with absolute alcohol and heating well while rubbing on a thin film of cement good adherence is obtained.

* The Ohio State University, Columbus, Ohio.

† University of Chicago, Chicago, Ill.

SUBJECT INDEX

- A
- Acetic acid-acetic anhydride, 85
Alkali azides, 79
Alkaline earth azides, 79
Alumino-oxalates, 36
Amalgams, 5
 concentration of, 17
 preparation of, 6
 rare earth metal, 15
Ammonium nitrourethane, 69
Ammonium perrenate, 177
Antimony oxyiodide, 105
Antimony triiodide, 104
Aquo-pentammino cobalti bromide, 187, 188
Arsenic triiodide, 103
Azides, 79
Azido-carbondisulfide, 81, 82
Azidodithiocarbonic acid, 81
Azidothioformic acid, 81
Azoimides, 79
- B
- Barium amalgam, 11
 by displacement method, 14
 by electrolytic method, 12
Barium paraperiodate, 171
Benzalazine, 92
 conversion of, 93, 94
Boron trifluoride, for catalysis, 23
 high purity, 21
Bromine solution, in carbon tetrachloride, 86
Bromopentamminocobalti bromide, 186
Bromoplumbic acid, 48
- C
- Carbon tetrafluoride, 34
Catalyst, boron trifluoride, 23
- D
- Dibromoamine, 62
 analysis of, 64
Dibromosilane, 38
- F
- Ferric oxide, gamma, 185
Ferric oxide monohydrate, gamma, 185
Ferri-oxalates, 36
Ferrous chloride, tetrapyridino, 184
Fluoborate, potassium, 24
Fluoboric acid, 25
Fluorine, 136
 high-temperature method, 138
 electrolyte for, 140
 medium-temperature method, 142
 electrolyte for, 143
- G
- Gallium, metallic, 26
Gallium trichloride, 26
- Cement, laboratory, 189
Cerium amalgam, 15
Cesium, metallic, 79
Chloroamine, 59
Chlorides, anhydrous, 28, 29
 of silicon, 42
Chloroplumbic acid, 48
Chromi-oxalates, 37
Chromous acetate, 122
Chromous chloride, 124, 125
 solution, 124
 tetrahydrate, 126
 trihydrate, 126
Cinnabar, 20
Cobalti-oxalates, 37

Guanidine nitrate, 94, 96, 97
 from calcium cyanamide, 97
 from dicyandiamide, 96

H

Haloplumbic acids, 48
 Hexachlorodisilane, 42
 Hexafluorides, of sulfur, selenium
 and tellurium, 121
 Hydrazine, 90
 Hydrazine dihydrochloride, 92
 Hydrazine residues, recovery of, 92
 Hydrazine sulfate, 90, 92
 Hydrazoic acid, 77, 78
 Hydriodic acid, 157, 159
 by action of iodine on hydrogen
 sulfide, 157
 constant boiling, 158
 fuming, 162
 stabilization of, 159
 Hydrobromic acid, 151, 152, 155
 constant boiling, 155
 (*See also* Hydrogen bromide)
 Hydrogen azide, 77
 ethereal solution, 77, 78
 Hydrogen bromide, 39, 114, 149,
 151, 152
 by bromination of tetrahydro-
 naphthalene, 151
 by direct combination over plati-
 nized silica gel, 152
 Hydrogen bromide gas, 150, 152
 Hydrogen chloride, 147
 Hydrogen fluoride, anhydrous, 134
 Hydrogen iodide, by catalytic union,
 159
 Hydrogen sulfide, liquid, 111
 Hydroxylamine, 87
 Hydroxylamine hydrochloride, re-
 covery of, 89
 Hypochlorite solution, 90
 Hypovanadous oxide, 106

I

Indium dichloride, 26
 Iodine monochloride, 165
 Iodine trichloride, 167

L

Laboratory cement, 189
 Lanthanum amalgam, 15
 Lanthanum chloride, anhydrous, 32
 Lead dioxide, 45
 Lead tetracetate, 47
 Lead thiocyanate, 85
 Lithium carbonate, purification of, 1

M

Magnesium chloride, anhydrous, 29
 Manganous chloride, anhydrous, 29
 Mercuric sulfide, red, 19
 Mercury, solubility of metals in, 6
 Metals, solubility in mercury, 6
 Monochloroamine, 59
 analysis of, 62

N

Neodymium amalgam, 15
 Neodymium chloride, anhydrous, 32
 Nitramide, 68, 72
 Nitrocarbamate, potassium, 70
 Nitrocarbamates, 68
 Nitrogen, pure, 79
 Nitrogen trichloride, 65
 analysis of, 67
 Nitrosyl chloride, 55
 analysis of, 57
 Nitrosylsulfuric acid, 55
 Nitrourethane, 69
 ammonium, 69

O

Octachlorotrisilane, 44
 Orthophosphoric acid, crystalline,
 101
 Oxygen fluoride, 109

P

Periodates, analysis of, 170
 barium, 168
 potassium, 168
 sodium, 168

- Periodic acid, 172
 solubility in nitric acid, 173
 Phosphoric acid, ortho-, crystalline, 101
 Phosphorus pentachloride, 99
 Phosphotungstic acid, 132
 ether complex, 133
 Platinized asbestos, 160
 Platinized silica gel, use in preparation of hydrogen bromide, 152
 Plumbates, 45
 Plumbic acid, 46
 Plumbic salts, 45
 Plumbous thiocyanate, 85
 Potassium, metallic, 79
 Potassium azide, 79
 Potassium chlororhenite, 178
 Potassium fluoborate, 24
 Potassium iodide, use as a primary standard, 163
 Potassium metaperiodate, 171
 Potassium nitrocarbamate, 68, 70
 Potassium trioxalatoaluminate, 36
 Potassium trioxalatochromiate, 37
 Potassium trioxalato cobaltiate, 37
 Potassium trioxalatoferriate, 36
- R
- Rare earth chlorides, anhydrous, 28
 Rare earth metals, 18
 amalgams, concentration of, 17
 Rhenium, metallic, 175
 by reduction of ammonium perchlorate, 177
 by reduction of potassium perchlorate, 176
 Rhenium pentachloride, 180
 Rhenium sulfide, 177
 Rhenium trichloride, 182
 Rubidium, metallic, 79
- S
- Selenium, red, 119
 Selenium dioxide, 117
 by combustion of selenium, 117
 Selenium dioxide, by oxidation of selenium by nitric acid, 119
 purification, 120
 Selenium hexafluoride, 121
 Silica gel, platinized, use in preparation of hydrogen bromide, 152
 Silicobromoform, 38
 analysis of, 41
 Silicoethane, hexachlor, 42
 Silicoformic anhydride, 42
 Silicomolybdic acid, 127
 analysis, 128
 Silicon, higher chlorides of, 42
 Silicon tetrabromide, 38, 40
 Silicon tetrachloride, 44
 Silicopropane, octachloro, 44
 Silicotungstic acid, 129
 analysis, 131
 ether complex, 131
 Silver, metallic, 4
 Silver chloride, reduction of, 3
 Silver cyanamide, 98
 Silver residues, purification of, 2
 Sodium amalgam, 10
 Sodium amide, 74
 Sodium azide, purification of, 79
 Sodium azidodithiocarbonate, 82
 Sodium butoxide, 88
 Sodium hypochlorite (solution), 90
 Sodium iodate, 168
 Sodium metaperiodate, 170
 Sodium paraperiodate, chlorine method, 169
 persulfate method, 170
 Strontium amalgam, 11
 Sulfur hexafluoride, 121
 Sulfuryl chloride, 114
- T
- Tellurium hexafluoride, 121
 Tetrabromosilane, 38, 40
 Tetrapyridino-ferrous chloride, 184
 Thiocyanogen solution, 84, 86
 standardization, 86
 Thionyl bromide, 113
 Thorium bromide, ammines, 54
 anhydrous, 51

- Thorium bromide, hydrates, 53
Thorium oxybromide, 54
Triazoates, 79
Tribromosilane, 38
 analysis of, 41
Trinitrides, 79
Trioxalato salts, 35
- V
- Vanadium oxide, black, 106
Vanadium oxytrichloride, 106
- Vanadium tetrachloride, 107
Vermilion, 20
- Y
- Yellow salt, 184
- Z
- Zirconium oxybromide, 51
Zirconium tetrabromide, anhydrous,
 49
Zirconyl bromide, 51